



Operator's Manual

Serial Number Range

S[®]-80 J

from S80JH-101

S[®]-80 J TraX[™]

ANSI/CSA
North America
South America
Asia

with
Maintenance
Information

Original Instructions
First Edition
Second Printing
Part No. 1306265GT

Contents

Introduction	1
Symbol and Hazard Pictorials Definitions.....	5
General Safety	8
Personal Safety.....	16
Work Area Safety.....	17
Legend	27
Controls.....	28
Inspections.....	36
Operating Instructions.....	51
Transport and Lifting Instructions	63
Maintenance	66
Specifications.....	70

Copyright © 2020 by Terex Corporation

First Edition: Second Printing, February 2023

Genie and "S" are registered trademarks of Terex South Dakota, Inc. in the U.S.A. and many other countries.

These machines comply with
ANSI/SAIA A92.20
CAN/CSA B354.6



Introduction

About this manual

Genie appreciates your choice of our machine for your application. Our number one priority is user safety, which is best achieved by our joint efforts. This book is an operation and daily maintenance manual for the user or operator of a Genie machine.

This manual should be considered a permanent part of your machine and should remain with the machine at all times. If you have any questions, contact Genie.

Product Identification

The machine serial number is located on the serial label.

Serial label
(located under cover)

Serial number stamped on
chassis



Intended Use and Familiarization Guide

The intended use of this machine is to lift personnel, including tools, and materials to an aerial work site. Before operating the machine, it's the operator's responsibility to read and understand this familiarization guide.

- Each person must be trained to operate a Mobile Elevating Work Platform (MEWP).
- Familiarization with the MEWP must be given to each person who is authorized, competent and trained.
- Only trained and authorized personnel should be permitted to operate the machine.
- The operator is responsible to read, understand, and obey the manufacturer's instructions and safety rules provided in the Operator's Manual.
- The Operator's Manual is located in the manual storage container, at the platform.
- For specific product applications, see **Contacting The Manufacturer**.

Introduction

Platform controls symbology and related machine movement:

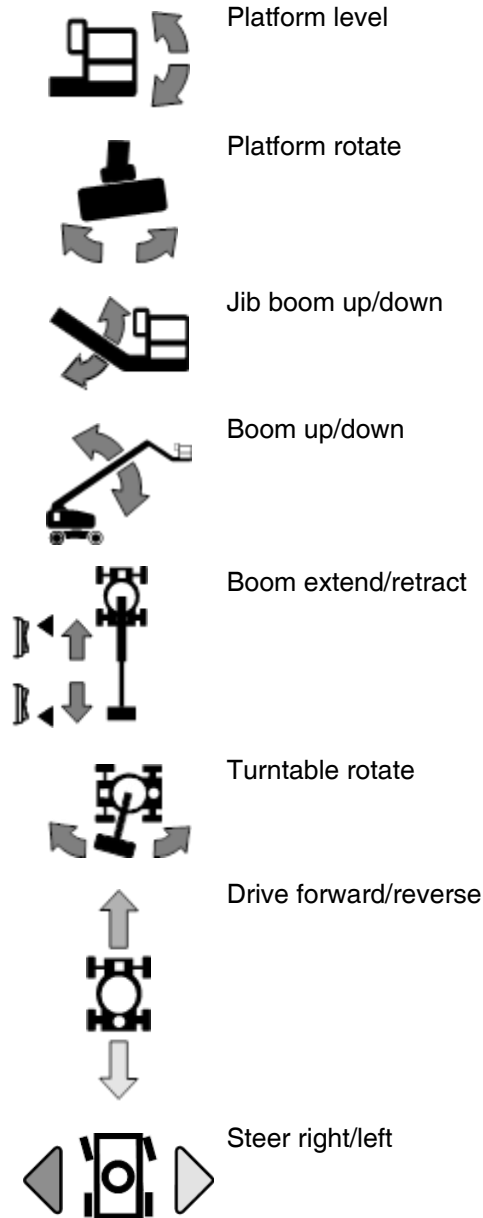

Ground controls symbology and related machine movement:

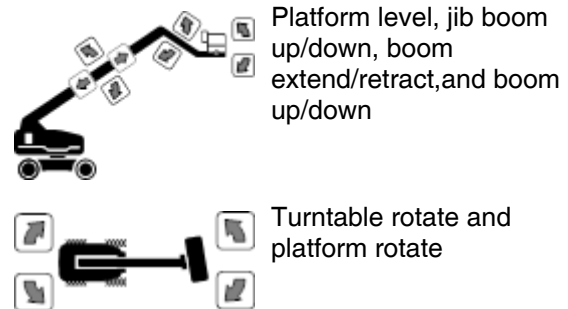

Sequential functions and movement:

- Drive and steer.

Interlocked functions:

- Elevated drive speed.
- Elevated drive in an off-level condition.
- Drive enable when the boom is rotated past the non-steer wheels, or non-steer tracks.
- All platform and ground controls.

Limitations of use:

- The intended use of this machine is to lift personnel, including tools, and materials to an aerial work site.
- Do not elevate the platform unless the machine is on firm level ground.

Stability enhancing means:

- Foam filled tires
- Tracks

Restricted operating envelope:

- Not restricted.

Introduction

Bulletin Distribution and Compliance

Safety of product users is of paramount importance to Genie. Various bulletins are used by Genie to communicate important safety and product information to dealers and machine owners.

The information contained in the bulletins is tied to specific machines using the machine model and serial number.

Distribution of bulletins is based on the most current owner on record along with their associated dealer, so it is important to register your machine and keep your contact information up to date.

To ensure safety of personnel and the reliable continued operation of your machine, be sure to comply with the action indicated in a respective bulletin.

To view any open bulletins for your machine, visit us on the web at www.genielift.com.

Contacting the Manufacturer

At times it may be necessary to contact Genie. When you do, be ready to supply the model number and serial number of your machine, along with your name and contact information. At minimum, Genie should be contacted for:

Accident reporting

Questions regarding product applications and safety

Standards and regulatory compliance information

Current owner updates, such as changes in machine ownership or changes in your contact information. See Transfer of Ownership, below.

Transfer of Machine Ownership

Taking a few minutes to update owner information will ensure that you receive important safety, maintenance and operating information that applies to your machine.

Please register your machine by visiting us on the web at www.genielift.com or by calling us toll free at 1-800-536-1800.

Introduction



Danger

Failure to obey the instructions and safety rules in this manual will result in death or serious injury.

Do Not Operate Unless:

- You learn and practice the principles of safe machine operation contained in this operator's manual.
 - 1 Avoid hazardous situations.**

Know and understand the safety rules before going on to the next section.

 - 2 Always perform a pre-operation inspection.
 - 3 Always perform function tests prior to use.
 - 4 Inspect the workplace.
 - 5 Only use the machine as it was intended.
- You read, understand and obey the manufacturer's instructions and safety rules—safety and operator's manuals and machine decals.
- You read, understand and obey employer's safety rules and worksite regulations.
- You read, understand and obey all applicable governmental regulations.
- You are properly trained to safely operate the machine.

Safety Sign Maintenance

Replace any missing or damaged safety signs. Keep operator safety in mind at all times. Use mild soap and water to clean safety signs. Do not use solvent-based cleaners because they may damage the safety sign material.

Hazard Classification

Decals on this machine use symbols, color coding, and signal words to identify the following:



Safety alert symbol—used to alert you to potential personal injury hazards. Obey all safety messages that follow this symbol to avoid possible injury or death.



Indicates a hazardous situation which, if not avoided, will result in death or serious injury.



Indicates a hazardous situation which, if not avoided, could result in death or serious injury.













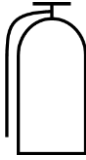

Indicates a hazardous situation which, if not avoided, could result in minor or moderate injury.



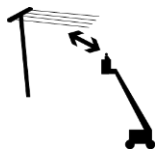

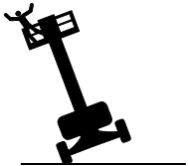





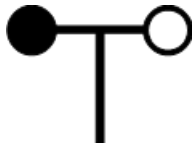

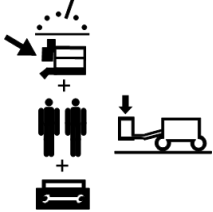
Indicates a property damage message.

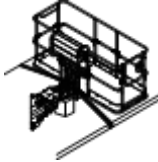





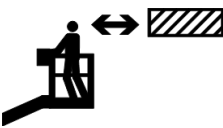



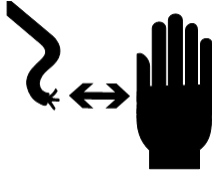

Symbol and Hazard Pictorials Definitions

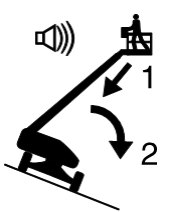
 <p>Fire hazard</p>	 <p>Explosion hazard</p>	 <p>Explosion hazard</p>	 <p>Do not use ether or other high energy starting aids on machines equipped with glow plugs.</p>	 <p>No smoking. No flame. Stop engine.</p>
 <p>Fire extinguisher</p>	 <p>No smoking</p>	 <p>Explosion hazard</p>	 <p>Electrocution hazard</p>	 <p>Maintain required clearance</p>
 <p>Tip-over hazard</p>	 <p>Tip-over hazard</p>	 <p>Tip-over hazard</p>	 <p>Tip-over hazard</p>	 <p>Tire specifications</p>

Symbol and Hazard Pictorials Definitions

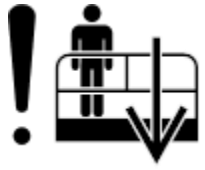
 <p>Wheel load</p>	 <p>Wind speed</p>	 <p>Maximum capacity</p>	 <p>Manual force</p>	 <p>Weight of welder reduces capacity</p>
 <p>Tie-down point</p>	 <p>Lifting point</p>	 <p>Platform tie-down instructions</p>	 <p>Lifting and tie down instructions</p>	 <p>Lanyard anchorage points</p>
 <p>Corrosive acid.</p>	 <p>Color coded direction arrows</p>	 <p>Runaway hazard</p>	 <p>Collision hazard</p>	 <p>Overhead obstruction</p>

Symbol and Hazard Pictorials Definitions

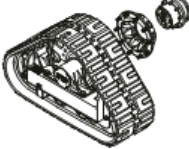
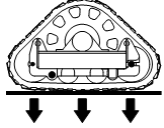

 <p>Electrocution hazard</p>	 <p>Avoid contact</p>	 <p>Disconnect battery</p>	 <p>Voltage rating for power to platform</p>	 <p>Pressure rating for air line to platform</p>
<p>Recovery procedure if tilt alarm sounds while elevated.</p> <div style="display: flex; justify-content: space-around;"> <div data-bbox="235 661 414 871">  <p>1 Retract boom.</p> </div> <div data-bbox="430 661 609 871">  <p>2 Lower boom.</p> </div> </div>		 <p>Read the operator's manual</p>	 <p>Access by trained and authorized personnel only</p>	 <p>Read the service manual</p>
 <p>Auxiliary lowering</p>	 <p>Crush hazard</p>	 <p>Support the platform or boom during maintenance</p>	 <p>Explosion hazard</p>	 <p>Relieve all pressure</p>
 <p>Replace tracks with same tracks.</p>	 <p>Tracks load</p>			

General Safety

* These decals are model, option or configuration specific.



Pictures in this manual may show a boom with tires and wheels instead of tracks. All safety information and operating instructions still apply to the S-80 J TRAX, even if the picture does not show the tracks.

147792

⚠ DANGER	
	Tip-over Hazard Do not use air-filled tires.
	This machine is equipped with foam-filled tires. Wheel weight is critical to stability.



35550 D235, Palletized
Minimum New Foam-filled Tire Weight: 415 lbs / 188 kg
Log Not Torque
Dry bolts: 245 Nm / 180 lbf-ft
Lubricated bolts: 180 Nm / 133 lbf-ft
244 Nm

133250

⚠ DANGER	
	Tip-over Hazard Failure to replace tracks with Genie approved tracks will result in death or serious injury.
	Tracks are critical to machine stability. Do not replace with tires. Refer to Genie parts manual for approved tracks.

Log Not Torque: 245 Nm / 180 lbf-ft
Dry bolts: 245 Nm / 180 lbf-ft
Lubricated bolts: 180 Nm / 133 lbf-ft
244 Nm
Other Torque: 426 Nm / 315 lbf-ft
Dry bolts: 213 Nm / 157 lbf-ft
Lubricated bolts: 157 Nm

147792

⚠ DANGER	
	Tip-over Hazard Do not use air-filled tires.
	This machine is equipped with foam-filled tires. Wheel weight is critical to stability.



35550 D235, Palletized
Minimum New Foam-filled Tire Weight: 415 lbs / 188 kg
Log Not Torque
Dry bolts: 245 Nm / 180 lbf-ft
Lubricated bolts: 180 Nm / 133 lbf-ft
244 Nm

133250



⚠ DANGER	
	Tip-over Hazard Failure to replace tracks with Genie approved tracks will result in death or serious injury.
	Tracks are critical to machine stability. Do not replace with tires. Refer to Genie parts manual for approved tracks.

Log Not Torque: 245 Nm / 180 lbf-ft
Dry bolts: 245 Nm / 180 lbf-ft
Lubricated bolts: 180 Nm / 133 lbf-ft
244 Nm
Other Torque: 426 Nm / 315 lbf-ft
Dry bolts: 213 Nm / 157 lbf-ft
Lubricated bolts: 157 Nm

31060

⚠ DANGER	
	Tip-over Hazard Altering or disabling sensors or limit switches can result in machine tip-over. Machine tip-over will result in death or serious injury.
	Do not alter or disable sensors and/or limit switches.

31060

⚠ DANGER	
	Tip-over Hazard Altering or disabling sensors or limit switches can result in machine tip-over. Machine tip-over will result in death or serious injury.
	Do not alter or disable sensors and/or limit switches.

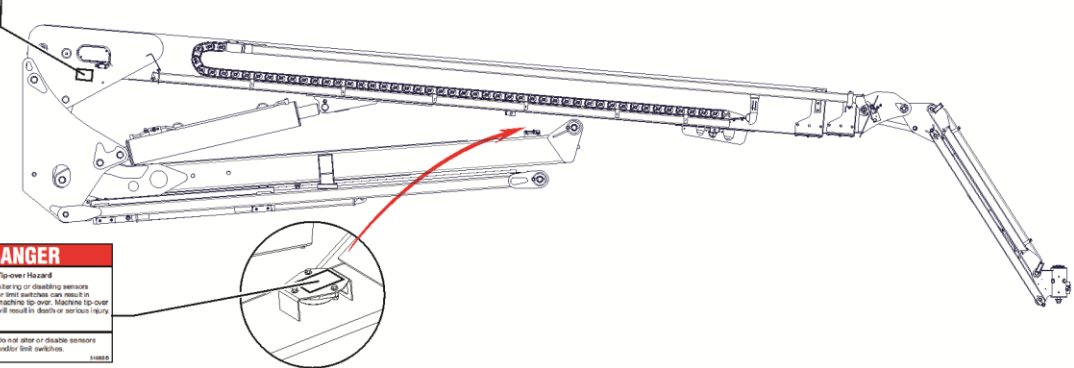
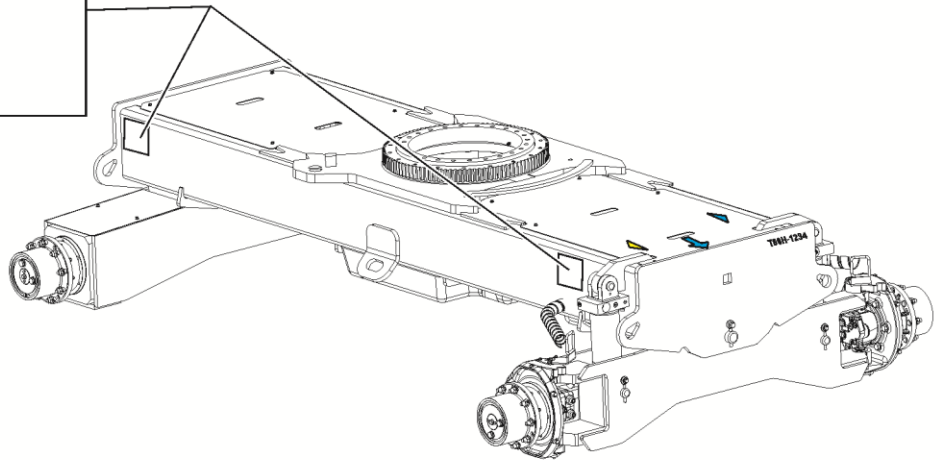
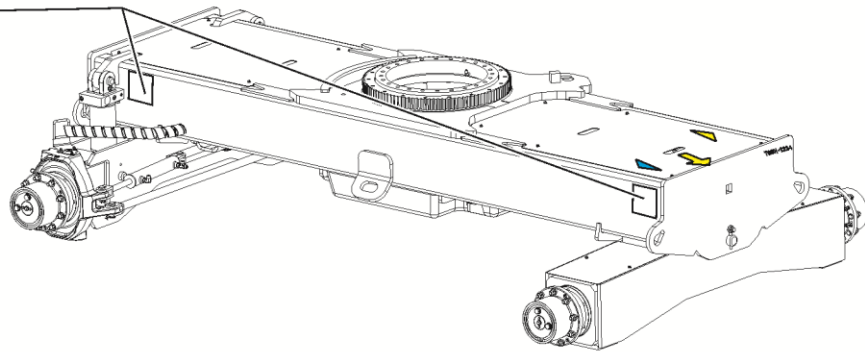

General Safety

* These decals are model, option or configuration specific.

Pictures in this manual may show a boom with tires and wheels instead of tracks. All safety information and operating instructions still apply to the S-80 J TRAX, even if the picture does not show the tracks.

97602

WARNING



Explosion Hazard
Death or serious injury can result from the use of ether or other high energy starting aids.



Do not use ether or other high energy starting aids on machines equipped with glow plugs or grid heaters.

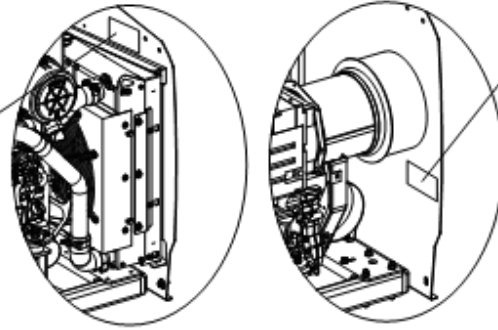

97602

WARNING



Explosion Hazard
Death or serious injury can result from the use of ether or other high energy starting aids.



Do not use ether or other high energy starting aids on machines equipped with glow plugs or grid heaters.

114258

DANGER



Burn Hazard
Fuel and fumes can explode and burn.



No smoking, no flame. Stop engine.

31788

DANGER



Caution: Skin Hazard
Spray of hydraulic fluid or contact with hydraulic oil will cause death, burns or blindness.



Never allow open flames and sparks near, blow, strike, glow or hot liquid with hydraulic equipment.



Wear eye protection.
Wear all personal protective gear to operation.
Do not operate equipment if you do not understand the information on the manual. Contact your supervisor, the dealer or the manufacturer.



97865

WARNING



Electrocution/Burn Hazard
Failure to disconnect all the batteries before performing service on this machine may result in death or serious injury.



Disconnect all the batteries before performing service on this machine.

DANGER



Struck by Falling Boom
Death or serious injury can result from the use of ether or other high energy starting aids.

Model	Weight	Height
S-80 J	10,000 lb	110 ft
S-80 J TraX	10,000 lb	110 ft
S-80 J	10,000 lb	110 ft
S-80 J TraX	10,000 lb	110 ft
S-80 J	10,000 lb	110 ft
S-80 J TraX	10,000 lb	110 ft
S-80 J	10,000 lb	110 ft
S-80 J TraX	10,000 lb	110 ft

114390

1263543

WARNING



Improper operation or maintenance of this equipment can result in death or serious injury.



Access by trained and authorized personnel only.

31060

DANGER



Falling Boom
Death or serious injury can result from the use of ether or other high energy starting aids.



Do not use ether or other high energy starting aids on machines equipped with glow plugs or grid heaters.

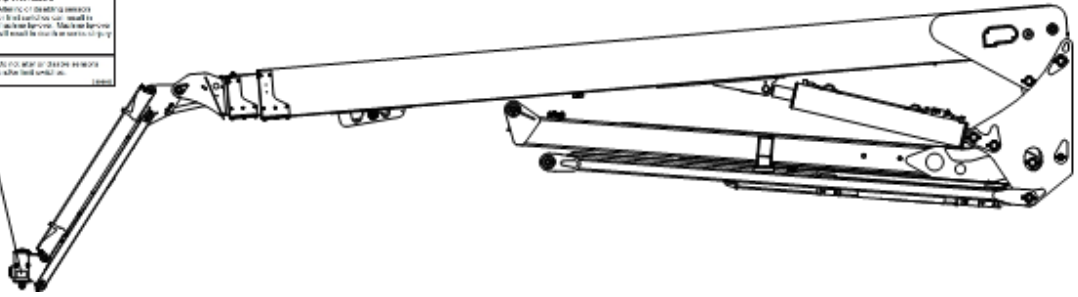

General Safety

* These decals are model, option or configuration specific.

Pictures in this manual may show a boom with tires and wheels instead of tracks. All safety information and operating instructions still apply to the S-80 J TRAX, even if the picture does not show the tracks.

82237
⚠ DANGER
Electrocution Hazard
Contact with energized components can result in death or serious injury.
Avoid contact with energized components.

72875
⚠ WARNING
Do not touch the boom or platform when the lift is in motion. The boom and platform are energized and can cause serious injury or death. Do not touch the boom or platform when the lift is in motion. The boom and platform are energized and can cause serious injury or death. Do not touch the boom or platform when the lift is in motion. The boom and platform are energized and can cause serious injury or death.

82410
⚠ WARNING
Do not touch the boom or platform when the lift is in motion. The boom and platform are energized and can cause serious injury or death. Do not touch the boom or platform when the lift is in motion. The boom and platform are energized and can cause serious injury or death. Do not touch the boom or platform when the lift is in motion. The boom and platform are energized and can cause serious injury or death.

114416
⚠ DANGER
Tip-over Hazard
If the lift is tipped, the platform can fall and cause serious injury or death. Do not touch the boom or platform when the lift is in motion. The boom and platform are energized and can cause serious injury or death. Do not touch the boom or platform when the lift is in motion. The boom and platform are energized and can cause serious injury or death.

219487
⚠ DANGER
Platform Overload Indicator Light
Do not touch the boom or platform when the lift is in motion. The boom and platform are energized and can cause serious injury or death. Do not touch the boom or platform when the lift is in motion. The boom and platform are energized and can cause serious injury or death. Do not touch the boom or platform when the lift is in motion. The boom and platform are energized and can cause serious injury or death.

1284011
⚠ DANGER
Maximum Platform Capacity
Do not touch the boom or platform when the lift is in motion. The boom and platform are energized and can cause serious injury or death. Do not touch the boom or platform when the lift is in motion. The boom and platform are energized and can cause serious injury or death. Do not touch the boom or platform when the lift is in motion. The boom and platform are energized and can cause serious injury or death.

114390
⚠ DANGER
Tip-over Hazard
If the lift is tipped, the platform can fall and cause serious injury or death. Do not touch the boom or platform when the lift is in motion. The boom and platform are energized and can cause serious injury or death. Do not touch the boom or platform when the lift is in motion. The boom and platform are energized and can cause serious injury or death.

97579
⚠ DANGER
Tip-over Hazard
If the lift is tipped, the platform can fall and cause serious injury or death. Do not touch the boom or platform when the lift is in motion. The boom and platform are energized and can cause serious injury or death. Do not touch the boom or platform when the lift is in motion. The boom and platform are energized and can cause serious injury or death.

218559
⚠ DANGER
⚠ WARNING
⚠ WARNING
Do not touch the boom or platform when the lift is in motion. The boom and platform are energized and can cause serious injury or death. Do not touch the boom or platform when the lift is in motion. The boom and platform are energized and can cause serious injury or death. Do not touch the boom or platform when the lift is in motion. The boom and platform are energized and can cause serious injury or death.

1309022
⚠ WARNING
Do not touch the boom or platform when the lift is in motion. The boom and platform are energized and can cause serious injury or death. Do not touch the boom or platform when the lift is in motion. The boom and platform are energized and can cause serious injury or death. Do not touch the boom or platform when the lift is in motion. The boom and platform are energized and can cause serious injury or death.

82862
⚠ DANGER
Fire Hazard
Serious injury or death will result if fire occurs while operating unless a fire extinguisher is not available. Do not touch the boom or platform when the lift is in motion. The boom and platform are energized and can cause serious injury or death. Do not touch the boom or platform when the lift is in motion. The boom and platform are energized and can cause serious injury or death.

28236
⚠ WARNING
Read and understand Operator's Manual, Responsibilities Manual and Safety Manual and all safety signs before using or maintaining machine. Do not touch the boom or platform when the lift is in motion. The boom and platform are energized and can cause serious injury or death. Do not touch the boom or platform when the lift is in motion. The boom and platform are energized and can cause serious injury or death.



General Safety

* These decals are model, option or configuration specific.

Pictures in this manual may show a boom with tires and wheels instead of tracks. All safety information and operating instructions still apply to the S-80 J TRAX, even if the picture does not show the tracks.

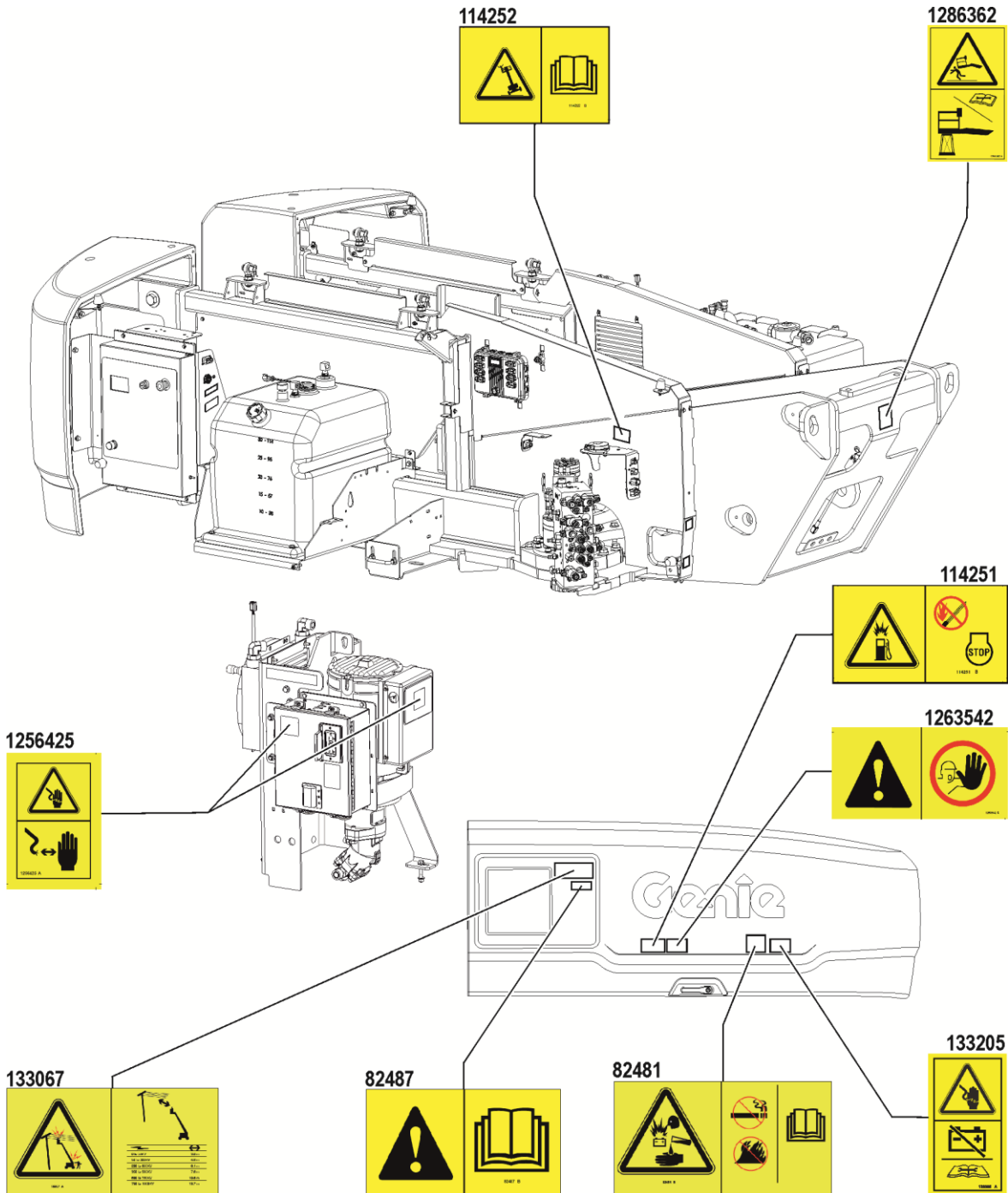

General Safety

* These decals are model, option or configuration specific.

Pictures in this manual may show a boom with tires and wheels instead of tracks. All safety information and operating instructions still apply to the S-80 J TRAX, even if the picture does not show the tracks.

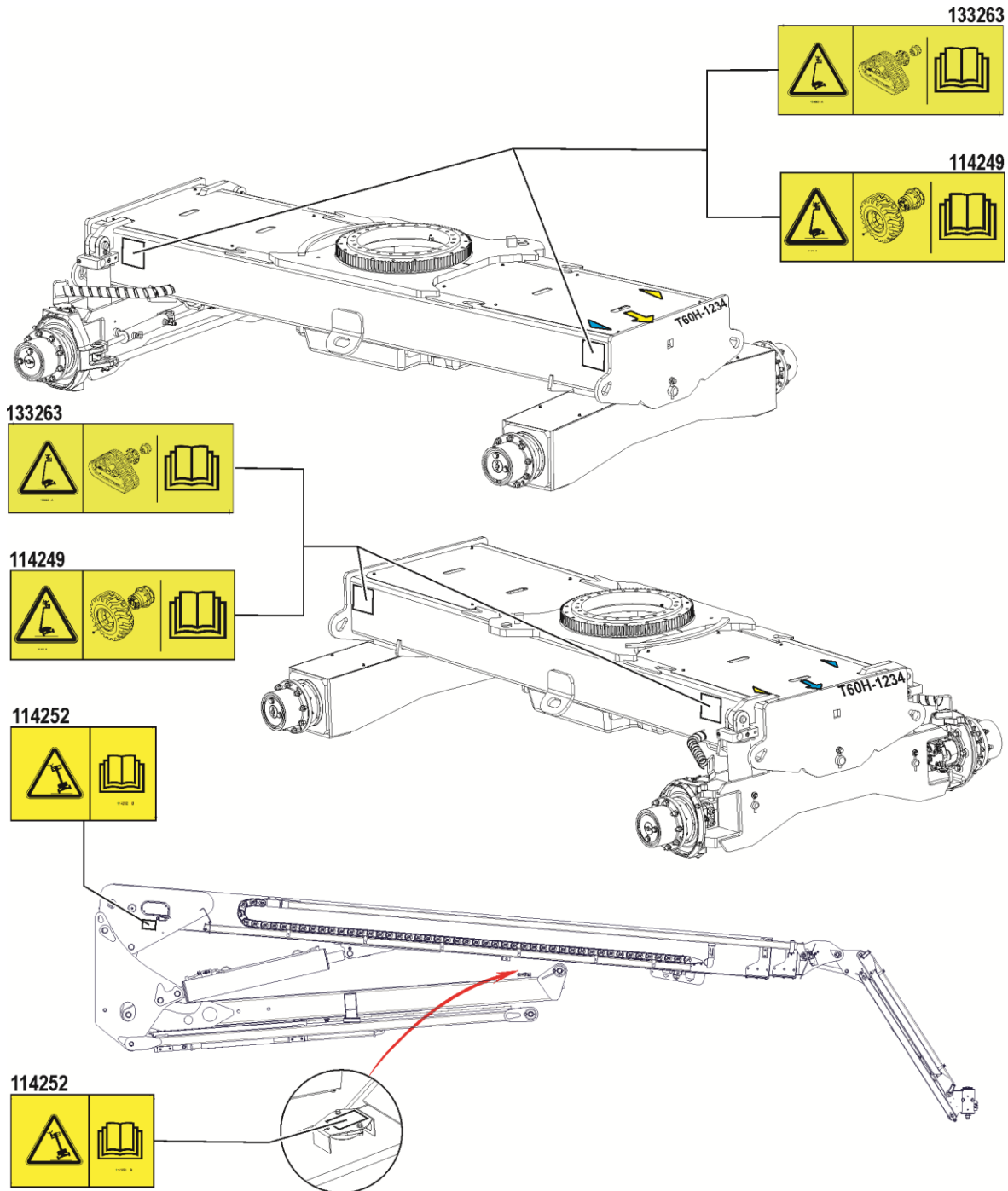

General Safety

* These decals are model, option or configuration specific.

Pictures in this manual may show a boom with tires and wheels instead of tracks. All safety information and operating instructions still apply to the S-80 J TRAX, even if the picture does not show the tracks.

1286362



1304217

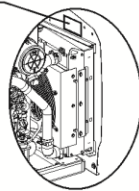

1263542



133205



82481



114251



133067

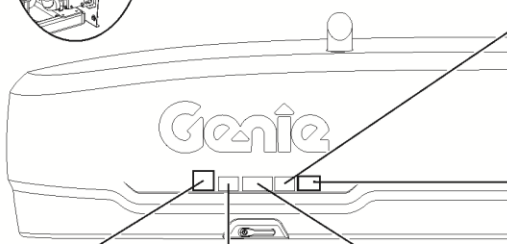

General Safety

* These decals are model, option or configuration specific.

Pictures in this manual may show a boom with tires and wheels instead of tracks. All safety information and operating instructions still apply to the S-80 J TRAX, even if the picture does not show the tracks.

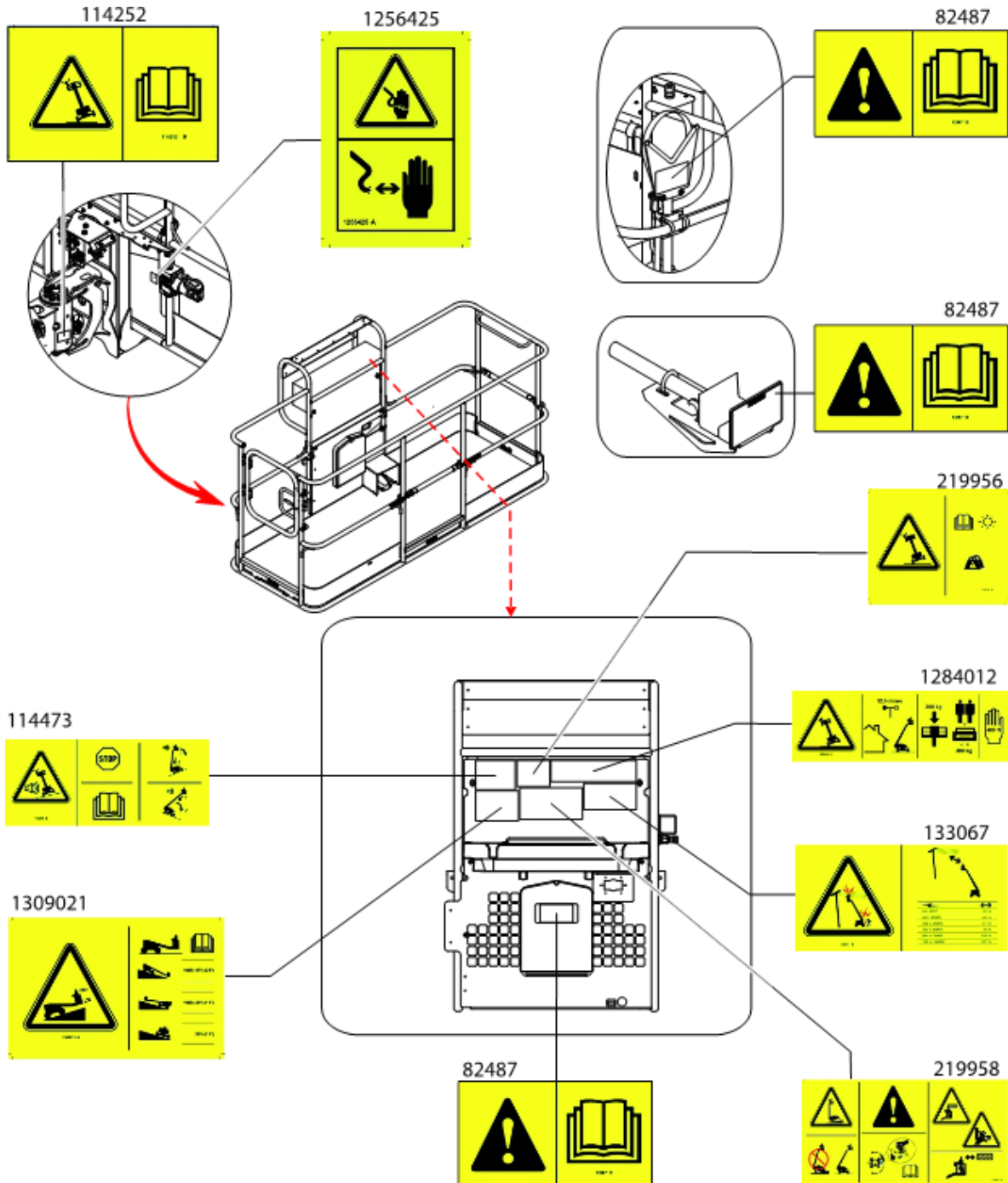

Personal Safety

Personal Fall Protection

Personal fall protection equipment (PFPE) is required when operating this machine.

Occupants must wear a safety belt or harness in accordance with governmental regulations. Attach the lanyard to the anchor provided in the platform.

Operators must comply with employer, job site and governmental rules regarding the use of personal protective equipment.

All PFPE must comply with applicable governmental regulations, and must be inspected and used in accordance with the PFPE manufacturer's instructions.

Work Area Safety

Pictures in this manual may show a boom with tires and wheels instead of tracks. All safety information and operating instructions still apply to the S-80 J TRAX, even if the picture does not show the tracks.

⚠ Electrocuting Hazards

This machine is not electrically insulated and will not provide protection from contact with or proximity to electrical current.



Obey all local and governmental regulations regarding required clearance from electrical power lines. At a minimum, the required clearance contained in the chart below must be followed.

Line Voltage	Required Clearance	
0 to 50KV	10 ft	3.05 m
50 to 200KV	15 ft	4.60 m
200 to 350KV	20 ft	6.10 m
350 to 500KV	25 ft	7.62 m
500 to 750KV	35 ft	10.67 m
750 to 1000KV	45 ft	13.72 m

Allow for platform movement, electrical line sway or sag, and beware of strong or gusty winds.



Keep away from the machine if it contacts energized power lines. Personnel on the ground or in the platform must not touch or operate the machine until energized power lines are shut off.

Do not operate the machine during lightning or storms.

Do not use the machine as a ground for welding.

⚠ Tip-over Hazards

Occupants, equipment and materials shall not exceed the maximum platform capacity.

Maximum platform capacity	660 lbs	300 kg
Maximum occupants	2	

The weight of options and accessories such as pipe cradles and welders will reduce the rated platform capacity, and must be subtracted from the platform capacity. See the decals with the options and accessories.

If using accessories, read, understand and obey the decals, instructions and manuals with the accessory.

Work Area Safety



Do not raise or extend the boom unless the machine is on a firm, level surface.



Do not depend on the tilt alarm as a level indicator. The tilt alarm sounds in the platform only when the machine is on a severe slope.

If the tilt alarm sounds when the platform is raised, use extreme caution. The machine not level indicator light will come on and the drive function in one or both directions will not operate. Identify the condition of the boom on the slope as shown below. Follow the steps to lower the boom before moving to a firm, level surface. Do not rotate the boom while lowering.

The recovery mode should be used only by trained and authorized personnel.



If the tilt alarm sounds with the platform uphill:

- 1 Lower the boom.
- 2 Retract the boom.



If the tilt alarm sounds with the platform downhill:

- 1 Retract the boom.
- 2 Lower the boom.



Do not raise the boom when wind speeds may exceed 28 mph/12.5 m/s. If wind speeds exceed 28 mph/12.5 m/s when the boom is raised, lower the boom and do not continue to operate the machine.

Do not operate the machine in strong or gusty winds. Do not increase the surface area of the platform or the load. Increasing the area exposed to the wind will decrease machine stability.

Work Area Safety



Use extreme care and slow speeds while driving the machine in the stowed position across uneven terrain, debris, unstable or slippery surfaces and near holes and drop-offs.

Do not drive the machine on or near uneven terrain, unstable surfaces or other hazardous conditions with the boom raised or extended.

Do not use the machine as a crane.

Do not push the machine or other objects with the boom.

Do not contact adjacent structures with the boom.

Do not tie the boom or platform to adjacent structures.

Do not place loads outside the platform perimeter.

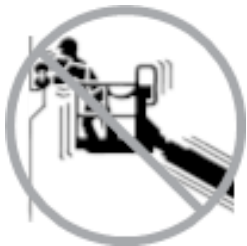

Do not push off or pull toward any object outside of the platform.

Maximum allowable manual force – 90 lbs/400 N

Do not alter or disable machine components that in any way affect safety and stability.

Do not replace items critical to machine stability with items of different weight or specification.

S-80 J: Do not replace factory-installed tires with tires of different specification or ply rating. Do not use air-filled tires. These machines are equipped with foam-filled tires. Wheel weight is critical to stability.

S-80 J Trax: Do not replace tracks with tires. Track weight is critical to stability. Do not replace factory-installed tracks with tracks of different specification.

Do not use the platform controls to free a platform that is caught, snagged, or otherwise prevented from normal motion by an adjacent structure. All personnel must be removed from the platform before attempting to free the platform using the ground controls.

Do not modify or alter a mobile elevated work platform without prior written permission from the manufacturer. Mounting attachments for holding tools or other materials onto the platform, toeboards, or guard rail system can increase the weight in the platform and the surface area of the platform or the load.

Work Area Safety



Do not place or attach fixed or overhanging loads to any part of this machine.



Do not place ladders or scaffolds in the platform or against any part of this machine.

Do not transport tools and materials unless they are evenly distributed and can be safely handled by person(s) in the platform.

Do not use the machine on a moving or mobile surface or vehicle.

Be sure the tires are in good condition and the lug nuts tightened.

⚠ Operation on Slopes Hazards

Do not drive the machine on a slope that exceeds the maximum uphill, downhill or side slope rating of the machine. Slope rating applies only to machines in the stowed position.

Maximum slope rating, stowed position, 4WD

Platform downhill	45% (24°)
Platform uphill	20% (11°)
Side slope	20% (11°)

Note: Slope rating is subject to ground conditions with one person in the platform and adequate traction. Additional platform weight may reduce slope rating. See Driving on a Slope in the Operating Instructions section.

Note: When side slope exceeds 17% / 10°, the turntable rotate function in one or both directions will be disabled. Drive the machine to level ground to restore turntable functions.

Work Area Safety

⚠ Fall Hazards



Occupants must wear a safety belt or harness in accordance with governmental regulations. Attach the lanyard to the anchor provided in the platform.



Do not sit, stand, or climb on the platform guard rails. Maintain a firm footing on the platform floor at all times.



Do not climb down from the platform when raised.

Keep the platform floor clear of debris.

Lower the platform entry mid-rail or close the entry gate before operating.

Do not enter or exit the platform unless the machine is in the stowed position and the platform is at ground level.

Hazards related with the specific product application of exiting at height have been considered in the design of the machine, for further information contact Genie (see section Contacting the Manufacturer).

⚠ Collision Hazards

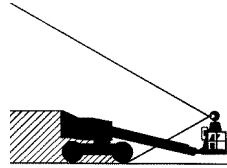

Be aware of limited sight distance and blind spots when driving or operating.

Be aware of the boom position and tailswing when rotating the turntable.



Check the work area for overhead obstructions or other possible hazards.



Be aware of crushing hazards when grasping the platform guard rail.

Operators must comply with employer, job site, and governmental rules regarding use of personal protective equipment.

Work Area Safety

Observe and use the color-coded direction arrows on the platform controls and drive chassis for drive and steer functions.



Do not lower the boom unless the area below is clear of personnel and obstructions.



Limit travel speed according to the condition of the ground surface, congestion, slope, location of personnel, and any other factors which may cause collision.

Do not operate a boom in the path of any crane unless the controls of the crane have been locked out and/or precautions have been taken to prevent any potential collision.

No stunt driving or horseplay while operating a machine.

▲ Bodily Injury Hazard

Always operate the machine in a well-ventilated area to avoid carbon monoxide poisoning.

Do not operate the machine with a hydraulic oil or air leak. An air leak or hydraulic leak can penetrate and/or burn skin.

Improper contact with components under any cover will cause serious injury. Only trained maintenance personnel should access compartments. Access by the operator is only advised when performing a pre-operation inspection. All compartments must remain closed and secured during operation.

▲ Explosion and Fire Hazards

Do not start the engine if you smell or detect liquid petroleum gas (LPG), gasoline, diesel fuel or other explosive substances.

Do not refuel the machine with the engine running.

Refuel the machine and charge the battery only in an open, well-ventilated area away from sparks, flames and lighted tobacco.

Do not operate the machine or charge the battery in hazardous locations or locations where potentially flammable or explosive gases or particles may be present.

Do not spray ether into engines equipped with glow plugs.

Work Area Safety

⚠ Damaged Machine Hazards

Do not use a damaged or malfunctioning machine.

Conduct a thorough pre-operation inspection of the machine and test all functions before each work shift. Immediately tag and remove from service a damaged or malfunctioning machine.

Be sure all maintenance has been performed as specified in this manual and the appropriate Genie service manual.

Be sure all decals are in place and legible.

Be sure the operator's, safety, and responsibilities manuals are complete, legible, and in the storage container located on the machine.

⚠ Component Damage Hazards

Do not use any battery or charger greater than 12V to jump-start the engine.

Do not use the machine as a ground for welding.

Do not operate the machine in locations where extremely high magnetic fields may be present.

⚠ Battery Safety

Burn Hazards



Batteries contain acid. Always wear protective clothing and eye wear when working with batteries.

Avoid spilling or contacting battery acid. Neutralize battery acid spills with baking soda and water.

Explosion Hazards



Keep sparks, flames, and lighted tobacco away from batteries. Batteries emit explosive gas.

⚠ Electrocutation Hazard

Avoid contact with electrical terminals.

Work Area Safety

⚠ Contact Alarm Safety

Read, understand and obey all warnings and instructions provided with the contact alarm.

Be sure the contact alarm is securely installed.

⚠ Pipe Cradle Safety

Read, understand, and obey all warnings and instructions provided with the pipe cradles.

Do not exceed the rated platform capacity. The pipe cradle assembly and the weight in the pipe cradles will reduce rated platform capacity and must be factored into total platform load.

The pipe cradle assembly weighs 21 lbs/9.5 kg.

The maximum capacity of the pipe cradle assembly is 200 lbs/91 kg.

The weight of the pipe cradle assembly and the load in the pipe cradles may limit the maximum number of occupants in platform.

Center the load within the perimeter of the platform.

Secure the load to the platform.

Do not obstruct the entrance or the exit of the platform.

Do not obstruct the ability to operate the platform controls or the red Emergency Stop button.

Do not operate unless you are adequately instructed and are aware of all of the hazards associated with movement of the platform with an overhanging load.

Do not cause a horizontal force or side load to machine by raising or lowering a fixed or overhanging load.

Electrocution Hazard: Keep pipes away from all energized electrical conductors.

Work Area Safety

▲ Panel Cradle Safety

Read, understand and obey all warnings and instructions provided with the panel cradles.

Do not exceed the rated platform capacity. The combined weight of the cradles, panels, occupants, tools and any other equipment must not exceed rated capacity.

The panel cradle assembly weighs 30 lbs/13.6 kg.

The maximum capacity of the panel cradles is 250 lbs/113 kg.

The weight of the panel cradles and the load in the panel cradles may limit the maximum number of occupants in platform to one person.

Secure the cradles to the platform. Secure the panel (s) to the platform railing using the straps provided.

Do not operate unless you are adequately instructed and are aware of all hazards associated with lifting panels.

Do not cause a horizontal force or side load to machine by raising or lowering a fixed or overhanging load.

Maximum vertical height of panels: 4 ft/1.2 m.

Maximum wind speed: 15 mph/6.7 m/sec.

Maximum panel area: 32 sq ft/3 m².

▲ Welder Safety

Read, understand and obey all warnings and instructions provided with the welding power unit.

Do not connect weld leads or cables unless the welding power unit is turned off at the platform controls.

Do not operate unless the weld cables are properly connected and the welder is properly grounded.

The weight of the welder will reduce the rated platform capacity and must be factored into the total platform load. The welder power supply weighs 75 lbs/34 kg.

Do not operate the welder unless a fire extinguisher is immediately available for instant use, per OSHA regulation 1926.352(d).

Work Area Safety

Lockout After Each Use

- 1 Select a safe parking location—firm level surface, clear of obstruction and traffic.
- 2 Retract and lower the boom to the stowed position.
- 3 Rotate the turntable so that the boom is between the non-steer wheels, or non-steer tracks.
- 4 Turn the key switch to the off position and remove the key to secure from unauthorized use.

Legend

Pictures in this manual may show a boom with tires and wheels instead of tracks. All safety information and operating instructions still apply to the S-80 J TRAX, even if the picture does not show the tracks.

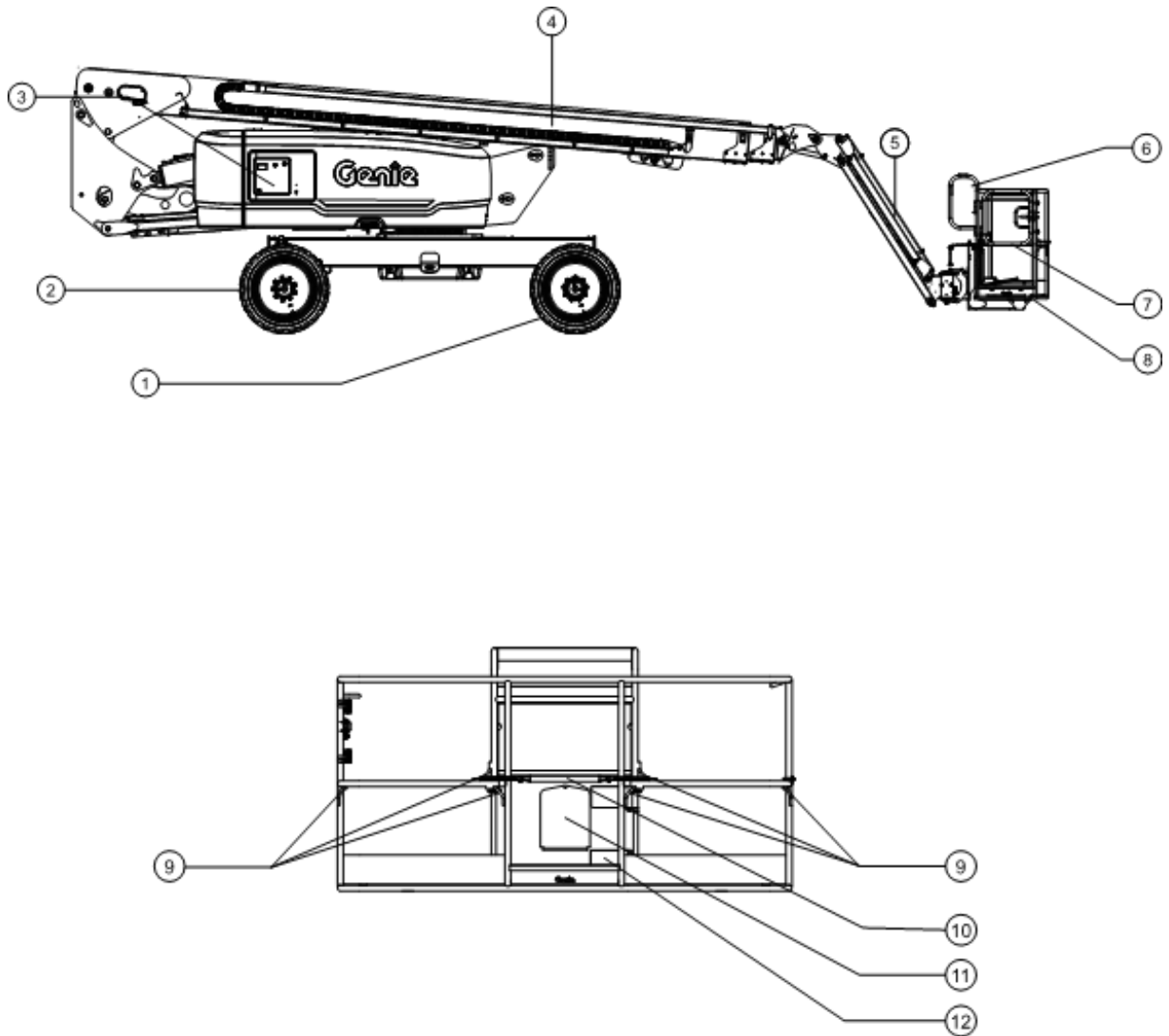

- | | |
|---------------------|-----------------------------|
| 1 Non-steer tire | 7 Swing gate |
| 2 Steer tire | 8 Platform |
| 3 Ground controls | 9 Lanyard anchorage points |
| 4 Boom | 10 Sliding mid-rail |
| 5 Jib boom | 11 Manual storage container |
| 6 Platform controls | 12 Foot switch |



Controls

Pictures in this manual may show a boom with tires and wheels instead of tracks. All safety information and operating instructions still apply to the S-80 J TRAX, even if the picture does not show the tracks.

The ground control station is to be used as a means to raise the platform for storage purposes and for function tests. The ground control station can be used in the event of an emergency to rescue an incapacitated person in the platform. When the ground control station is selected, the platform controls are inoperable, including the E-stop switch.

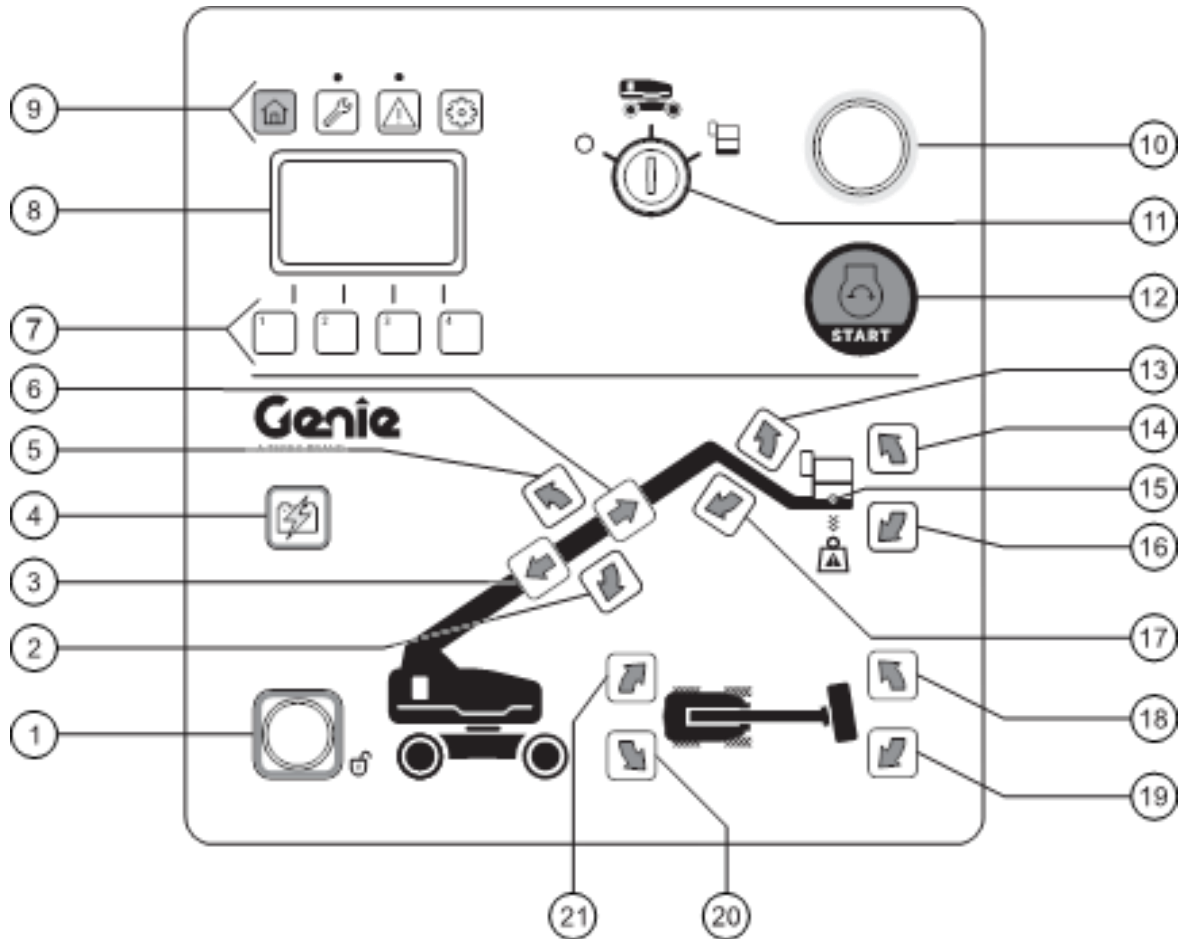

Ground Control Panel

Controls

Ground Control Panel

1 Function enable button

Press and hold the function enable button to enable the functions on the ground control panel to operate.

2 Boom down button

Press the boom down button and the boom will lower.

3 Boom retract button

Press the boom retract button and the boom will retract.

4 Auxiliary power button

Use auxiliary power if the primary power source (engine) fails. Simultaneously hold the auxiliary power button and activate the desired function.

5 Boom up button

Press the boom up button and the boom will raise.

6 Boom extend button

Press the boom extend button and the boom will extend.

7 LCD readout screen navigation buttons

8 LCD readout screen

Screen displays hour meter, voltage, oil pressure and coolant temperature. Screen also displays fault codes and other service information.

9 LCD screen menu buttons

Use the LCD screen menu buttons to access different menus.



The Home button will show the model, hour meter and access to engine gauges.



The Maintenance button will show the maintenance interval screen. Light on indicates a service interval has lapsed.



The Fault button will show current faults and allow access to fault logs. Light on indicates an active fault condition.



The Setup button allows service personnel to access configuration screens.

10 Red Emergency Stop button

Push in the red Emergency Stop button to the off position to stop all functions and turn the engine off. Pull out the red Emergency Stop button to the on position to operate the machine.

Controls

- 11 Key switch for off/ground/platform selection
Turn the key switch to the off position and the machine will be off. Turn the key switch to the ground position and the ground controls will operate. Turn the key switch to the platform position and the platform controls will operate.
- 12 Engine start button
Press the engine start button to start the engine.
- 13 Jib boom up button
Press the jib boom up button and the jib boom will raise.
- 14 Platform level up button
Press the platform level up button and the level of the platform will raise.
- 15 Platform overload indicator light
Light flashing indicates the platform is overloaded. The engine will stop and no functions will operate.

Note: An alarm will sound at the platform when an overload condition occurs and will stop sounding when weight is removed from the platform.
- 16 Platform level down button
Press the platform level down button and the level of the platform will lower.
- 17 Jib boom down button
Press the jib boom down button and the jib boom will lower.
- 18 Platform rotate right button
Press the platform rotate right button and the platform will rotate to the right.
- 19 Platform rotate left button
Press the platform rotate left button and the platform will rotate to the left.
- 20 Turntable rotate right button
Press the turntable rotate right button and the turntable will rotate to the right.
- 21 Turntable rotate left button
Press the turntable rotate left button and the turntable will rotate to the left.

Controls

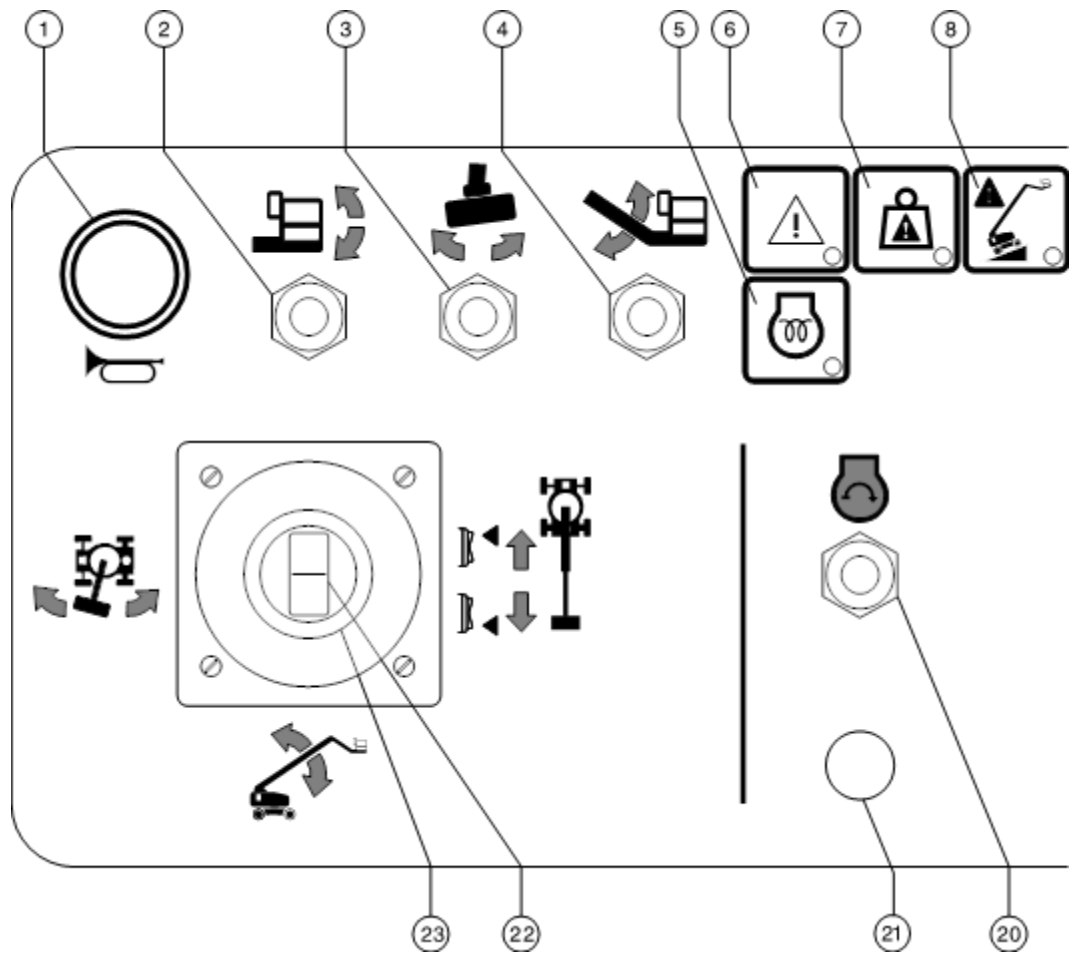

Platform Control Panel

Controls

Platform Control Panel

1 Horn button

Press this button and the horn will sound. Release the button and the horn will stop.

2 Platform level switch

Move the platform level switch up and the level of the platform will raise. Move the platform level switch down and the level of the platform will lower.



3 Platform rotate switch

Move the platform rotate switch to the left and the platform will rotate left. Move the platform rotate switch to the right and the platform will rotate right.



4 Jib boom up/down switch

Move the jib boom switch up and the jib boom will raise. Move the jib boom switch down and the jib boom will lower.



5 Glow plug indicator light

Light on indicates the glow plugs are on.

6 Fault indicator light

Light on indicates a system fault.

7 Platform overload indicator light

Light flashing indicates the platform is overloaded. The engine will stop and no functions will operate. Remove weight until the light goes off and then restart the engine.

8 Machine on incline indicator light

Light on indicates the tilt sensor activation settings have been exceeded. See the instructions in the Operating Instructions section.

9 Generator indicator light

Light on indicates the generator is in use.

10 Generator switch (if equipped)

Move the generator switch up to activate the generator. Move the switch down to turn off the generator.

11 Aircraft protection override switch (if equipped)

Move and hold the aircraft protection override switch to operate the machine when the platform bumper is against an object.

12 Red Emergency Stop button

Push in the red Emergency Stop button to the off position to stop all functions and turn the engine off. Pull out the red Emergency Stop button to the on position to operate the machine.

Controls

- 13 Dual axis proportional control handle for drive and steer functions.
OR
Proportional control handle for drive function and thumb rocker for steer function.
- Move the control handle in the direction indicated by the blue arrow on the control panel and the machine will drive forward. Move the control handle in the direction indicated by the yellow arrow and the machine will drive backwards. Move the control handle in the direction indicated by the blue triangle and the machine will steer to the left. Move the control handle in the direction indicated by the yellow triangle and the machine will steer to the right.
- OR
Move the control handle in the direction indicated by the blue arrow on the control panel and the machine will drive forward. Move the control handle in the direction indicated by the yellow arrow and the machine will drive backwards. Press the left side of the thumb rocker and the machine will steer to the left. Press the right side of the thumb rocker and the machine will steer to the right.
- 14 Drive enable indicator light
- Light flashing indicates that the boom has moved just past either non-steer wheel and drive function has been interrupted.
- 15 Drive enable switch
- To drive when the drive enable light is flashing, hold the drive enable switch to either side and slowly move the drive control handle off center. Be aware that the machine may move in the opposite direction that the drive and steer controls are moved.
- 16 Drive speed select switch
- Machine on incline symbol: Low range operation for inclines.
Machine on level surface symbol: High range operation for maximum drive speed.
- 17 Not used
- 18 Auxiliary power switch
- Use auxiliary power if the primary power source (engine) fails. Simultaneously hold the auxiliary power switch to either side and activate the desired function.
- 19 Engine RPM select switch
- Move the engine RPM select switch to the turtle position to activate low idle. Move the engine RPM speed select switch to the rabbit position to activate high idle.
- 20 Engine start switch
- Move the engine start switch to either side to start the engine.
- 21 Not used

Controls

- 22 Thumb rocker switch for boom extend/retract function

Push the top of the rocker switch and boom will retract.
Push the bottom of the rocker switch and the boom will extend.



- 23 Dual axis proportional control handle for boom up/down and turntable rotate left/right functions

Move the control handle up and the boom will raise. Move the control handle down and the boom will lower.



Move the control handle to the right and the turntable will rotate to the right. Move the control handle to the left and the turntable will rotate to the left.



Inspections

Pictures in this manual may show a boom with tires and wheels instead of tracks. All safety information and operating instructions still apply to the S-80 J TRAX, even if the picture does not show the tracks.



Do Not Operate Unless:

- You learn and practice the principles of safe machine operation contained in this operator's manual.
 - 1 Avoid hazardous situations.
 - 2 Always perform a pre-operation inspection.**

Know and understand the pre-operation inspection before going on to the next section.
 - 3 Always perform function tests prior to use.
 - 4 Inspect the workplace.
 - 5 Only use the machine as it was intended.

Pre-operation Inspection Fundamentals

It is the responsibility of the operator to perform a pre-operation inspection and routine maintenance.

The pre-operation inspection is a visual inspection performed by the operator prior to each work shift. The inspection is designed to discover if anything is apparently wrong with a machine before the operator performs the function tests.

The pre-operation inspection also serves to determine if routine maintenance procedures are required. Only routine maintenance items specified in this manual may be performed by the operator.

Refer to the list on the next page and check each of the items.

If damage or any unauthorized variation from factory delivered condition is discovered, the machine must be tagged and removed from service.

Repairs to the machine may only be made by a qualified service technician, according to the manufacturer's specifications. After repairs are completed, the operator must perform a pre-operation inspection again before going on to the function tests.

Scheduled maintenance inspections shall be performed by qualified service technicians, according to the manufacturer's specifications and the requirements listed in the responsibilities manual.

Inspections

Pre-operation Inspection

- Verify the operator's manual, safety manual, responsibilities manual and any necessary supplements are complete, legible and in the storage container located in the platform.
- Check for engine oil leaks and proper oil level. Add oil if needed. See Maintenance section.
- Check for engine coolant leaks and proper level of coolant. Add coolant if needed. See Maintenance section.
- Be sure that all decals are legible and in place. See Inspections section.
- Check for hydraulic oil leaks and proper oil level. Add oil if needed. See Maintenance section.
- Check for battery fluid leaks and proper fluid level. Add distilled water if needed. See Maintenance section.
- Check rubber tracks for signs of wear, cracks and cuts.

Check the following components or areas for damage, improperly installed, or missing parts and unauthorized modifications:

- Electrical components, wiring, and electrical cables
- Hydraulic hoses, fittings, cylinders, and manifolds
- Fuel and hydraulic tanks
- Drive and turntable motors and drive hubs
- Wear pads

- Tires and wheels
- Engine and related components
- Limit switches and horn
- Contact alarm
- Tracks, sprocket, idler, bogey, undercarriage/frame, tensioner
- Primary boom angle sensor
- Turntable level sensor
- Alarms and beacons (if equipped)
- Nuts, bolts and other fasteners
- Platform entry mid-rail and gate
- Platform load cell
- Lanyard anchorage points

Check entire machine for:

- Cracks in welds or structural components
- Dents or damage to machine
- Excessive rust, corrosion or oxidation
- Verify that all structural and other critical components are present and all associated fasteners and pins are in place and properly tightened.
- After you complete your inspection, be sure that all compartment covers are in place and latched.

Pictures in this manual may show a boom with tires and wheels instead of tracks. All safety information and operating instructions still apply to the S-80 J TRAX, even if the picture does not show the tracks.

Inspections



Do Not Operate Unless:

- You learn and practice the principles of safe machine operation contained in this operator's manual.
 - 1 Avoid hazardous situations.
 - 2 Always perform a pre-operation inspection.
 - 3 Always perform function tests prior to use.**

Know and understand the function tests before going on to the next section.

- 4 Inspect the workplace.
- 5 Only use the machine as it was intended.

Function Test Fundamentals

The function tests are designed to discover any malfunctions before the machine is put into service. The operator must follow the step-by-step instructions to test all machine functions.

A malfunctioning machine must never be used. If malfunctions are discovered, the machine must be tagged and removed from service. Repairs to the machine may only be made by a qualified service technician, according to the manufacturer's specifications.

After repairs are completed, the operator must perform a pre-operation inspection and function tests again before putting the machine into service.

Inspections

At the Ground Controls

- 1 Select a test area that is firm, level and free of hazards.
- 2 Turn the key switch to ground control.
- 3 Pull out the red Emergency Stop button to the on position.
- ⊙ Result: The alarm should sound at the ground controls.
- 4 Start the engine. See Operating Instructions section.
- ⊙ Result: The beacons (if equipped) should flash.

Test Emergency Stop

- 5 Push in the red Emergency Stop button to the off position.
- ⊙ Result: The engine should shut off and no functions should operate.
- 6 Pull out the red Emergency Stop button to the on position and restart the engine.

Test Machine Functions

- 7 Do not push the function enable button. Attempt to activate each boom and platform function button.
 
- ⊙ Result: No boom and platform functions should operate.
- 8 Press and hold the function enable button and activate each boom and platform function button.
- ⊙ Result: All boom and platform functions should operate through a full cycle. The descent alarm should sound while the boom is lowering.

Test the Tilt Sensor

- 9 Press the Maintenance button above the LCD screen. Navigate to the Real-time Data screen.
 
- ⊙ Result: The LCD screen should display the chassis angle and boom angle in degrees.

Inspections

Test Auxiliary Power

- 10 Turn the key switch to ground control and shut the engine off.
- 11 Pull out the red Emergency Stop button to the on position.
- 12 Simultaneously push the auxiliary power button and activate each boom function button.



Note: To conserve battery power, test each function through a partial cycle.

- ⦿ Result: All boom functions should operate.
- 13 Turn the key switch to platform control.

At the Platform Controls

Test the Tilt Sensor Alarm

- 14 Enter the platform and pull out the red Emergency Stop button.
- ⦿ Result: The alarm should sound at the platform controls.

Test Emergency Stop

- 15 Start the engine.
 - 16 Push in the platform red Emergency Stop button to the off position.
- ⦿ Result: The engine should shut off and no functions should operate.
- 17 Pull out the red Emergency Stop button and restart the engine.

Test the Horn

- 18 Press the horn button.
- ⦿ Result: The horn should sound.

Test the Foot Switch

- 19 Push in the platform red Emergency Stop button to the off position.
 - 20 Pull out the red Emergency Stop button to the on position and do not start the engine.
 - 21 Press down the foot switch and attempt to start the engine by moving the start toggle switch to either side.
- ⦿ Result: The engine should not start.
- 22 Do not press down the foot switch and restart the engine.
- ⦿ Result: The engine should start.
- 23 Do not press down the foot switch and test each machine function.
- ⦿ Result: No functions should operate.

Inspections

Test Machine Functions

- 24 Press down the foot switch.
- 25 Activate each machine function control handle or toggle switch.
- ⊙ Result: All boom and platform functions should operate through a full cycle.

Test the Steering

- 26 Press down the foot switch.
- 27 Press the thumb rocker switch on top of the drive control handle in the direction indicated by the blue triangle on the control panel OR slowly move the control handle in the direction indicated by the blue triangle.
- ⊙ Result: The steer wheels, or steer tracks should turn in the direction that the blue triangles point on the drive chassis.
- 28 Press the thumb rocker switch in the direction indicated by the yellow triangle on the control panel OR slowly move the control handle in the direction indicated by the yellow triangle.
- ⊙ Result: The steer wheels, or steer tracks should turn in the direction that the yellow triangles point on the drive chassis.

Test Drive and Braking

- 29 Press down the foot switch.
- 30 Slowly move the drive control handle in the direction indicated by the blue arrow on the control panel until the machine begins to move, then return the handle to the center position.
- ⊙ Result: The machine should move in the direction that the blue arrow points on the drive chassis, then come to an abrupt stop.
- 31 Slowly move the control handle in the direction indicated by the yellow arrow on the control panel until the machine begins to move, then return the handle to the center position.
- ⊙ Result: The machine should move in the direction that the yellow arrow points on the drive chassis, then come to an abrupt stop.

Note: The brakes must be able to hold the machine on any slope it is able to climb.

Test the Oscillating Axle

- 32 Start the engine from the platform controls.
- 33 Drive the right steer tire up onto a 6 in/15 cm block or curb.
- ⊙ Result: The three remaining tires should stay in firm contact with the ground.
- 34 Drive the left steer tire up onto a 6 in/15 cm block or curb.
- ⊙ Result: The three remaining tires should stay in firm contact with the ground.
- 35 Drive both steer tires up onto a 6 in/15 cm block or curb.
- ⊙ Result: The non-steer tires should stay in firm contact with the ground.

Inspections

Test the Drive Enable System

- 36 Press down the foot switch and lower the boom to the stowed position.
- 37 Rotate the turntable until the boom moves past one of the non-steer wheels, or non-steer tracks.

- ⊙ Result: The drive enable indicator light should flash while the boom is anywhere in the range shown.



- 38 Move the drive control handle off center.
- ⊙ Result: The drive function should not operate.
- 39 Move and hold the drive enable toggle switch to either side and slowly move the drive control handle off center.
- ⊙ Result: The drive function should operate.

Note: When the drive enable system is in use, the machine may drive in the opposite direction that the drive and steer control handle is moved.

Use the color-coded direction arrows on the platform controls and the drive chassis to identify the direction of travel.

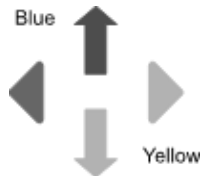

Test Limited Drive Speed

- 40 Press down the foot switch.
- 41 Raise the boom approximately 5° above horizontal.

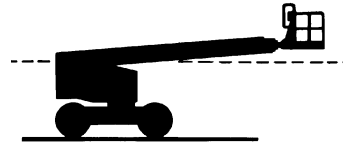

- 42 Slowly move the control handle to full drive position.
- ⊙ Result: The maximum achievable drive speed with the boom extended should not exceed 1 ft/30 cm per second.
- 43 Lower the boom to the stowed position.
- 44 Extend the boom 18 inches/46 cm.
- 45 Slowly move the control handle to full drive position.
- ⊙ Result: The maximum achievable drive speed with the boom extended should not exceed 1 ft/30 cm per second.

If the drive speed with the boom raised or extended exceeds 1 ft/30 cm per second, immediately tag and remove the machine from service.

Inspections

Test Drive Tilt Cutout

- 46 Press down the foot switch.
- 47 With the boom fully stowed, drive the machine onto a slope where the machine pitch angle is greater than 4.5° (front to back).
 - ⦿ Result: The machine should continue to drive.
- 48 Return the machine to level ground and extend the boom approximately 18 inches/46 cm.
- 49 Drive the machine onto a slope where the pitch angle is greater than 4.5° (front to back).
 - ⦿ Result: The machine should stop once the machine reaches 4.5° of chassis tilt and the alarm should sound at the platform controls.
- 50 Retract the boom to the stowed position.
 - ⦿ Result: The machine should drive.
- 51 Return to level ground and raise the boom to approximately 4.5° above horizontal.
- 52 Drive the machine onto a slope where the pitch angle is greater than 4.5° (front to back).
 - ⦿ Result: The machine should stop once the machine reaches 4.5° of chassis tilt and the alarm should sound at the platform controls.
- 53 While on the slope, attempt to raise and extend the boom.
 - ⦿ Result: The boom raise and extend functions should not operate.
- 54 Lower the boom to the stowed position.
 - ⦿ Result: The machine should drive.
- 55 Return to level ground and stow the boom.
- 56 Press down the foot switch.
- 57 With the boom fully stowed, drive the machine onto a slope where the roll angle is greater than 4.5° (side to side).
 - ⦿ Result: The machine should continue to drive.
- 58 Return the machine to level ground and extend the boom approximately 18 inches/46 cm.
- 59 Drive the machine onto a slope where the roll angle is greater than 4.5° (side to side).
 - ⦿ Result: The machine should stop once the machine reaches 4.5° of chassis tilt and the alarm should sound at the platform controls.
- 60 Retract the boom to the stowed position.
 - ⦿ Result: The machine should drive.
- 61 Return to level ground and raise the boom to approximately 4.5° above horizontal.
- 62 Drive the machine onto a slope where the roll angle is greater than 4.5° (side to side).
 - ⦿ Result: The machine should stop once the machine reaches 4.5° of chassis tilt and the alarm should sound at the platform controls.
- 63 While on the slope, attempt to raise and extend the boom.
 - ⦿ Result: The boom raise and extend functions should not operate.
- 64 Lower the boom to the stowed position.
 - ⦿ Result: The machine should drive.
- 65 Return to level ground and stow the boom.

Inspections

Test the Lift/Drive Select Function (if equipped)

- 66 Start the engine.
- 67 Press down the foot switch.
- 68 Move the drive control handle off center and activate a boom function control handle.
- ⊙ Result: No boom functions should operate. The machine will move in the direction indicated on the control panel.

Test the Contact Alarm (if equipped)

- 69 Do not activate the foot switch and press on the contact alarm cable to release the actuator from the switch socket.
- ⊙ Result: The contact alarm lights will not flash and the machine horn will not sound.
- 70 Activate the foot switch by pressing the foot switch down.
- ⊙ Result: The contact alarm lights will flash and the machine horn will sound.
- 71 Insert the actuator into the switch socket.
- ⊙ Result: The lights and horn will turn off.
- 72 Activate the foot switch by pressing the foot switch down and press on the contact alarm cable to release the actuator from the switch socket.
- ⊙ Result: The contact alarm lights will flash and the machine horn will sound.

- 73 Operate each machine function.
- ⊙ Result: All machine functions should not operate.
- 74 Insert the actuator into the switch socket.
- ⊙ Result: The lights and horn will turn off.
- 75 Operate each machine function.
- ⊙ Result: All machine functions should operate.

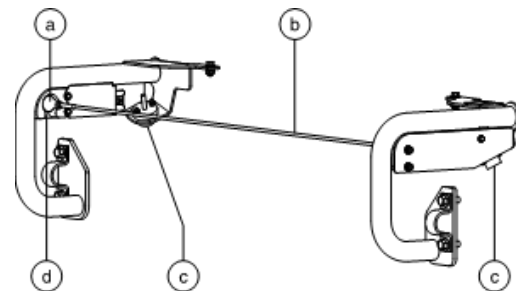

- a actuator
- b contact alarm cable
- c flashing alarm
- d switch socket

Inspections

Test Auxiliary Controls

- 76 Shut off the engine.
- 77 Pull out the red Emergency Stop button to the on position.
- 78 Press down the foot switch.
- 79 Simultaneously hold the auxiliary power switch on and activate each function control handle or toggle switch.

Note: To conserve battery power, test each function through a partial cycle.

- ⦿ Result: All boom functions should operate. Drive functions should not operate with auxiliary power.

Test Aircraft Protection Package (if equipped)

Note: Two people may be required to perform this test.

- 80 Move the yellow bumper at the bottom of the platform 4 inches/10 cm in any direction.
- 81 Activate each function control handle or toggle switch.
 - ⦿ Result: No boom and steer functions should operate.
- 82 Move and hold the function override switch.
- 83 Activate each function control handle or toggle switch.
 - ⦿ Result: All boom and steer functions should operate.

Inspections



Do Not Operate Unless:

- You learn and practice the principles of safe machine operation contained in this operator's manual.
 - 1 Avoid hazardous situations.
 - 2 Always perform a pre-operation inspection.
 - 3 Always perform function tests prior to use.
 - 4 Inspect the workplace.**

Know and understand the workplace inspection before going on to the next section.
 - 5 Only use the machine as it was intended.

Workplace Inspection Fundamentals

The workplace inspection helps the operator determine if the workplace is suitable for safe machine operation. It should be performed by the operator prior to moving the machine to the workplace.

It is the operator's responsibility to read and remember the workplace hazards, then watch for and avoid them while moving, setting up, and operating the machine.

Workplace Inspection Checklist

Be aware of and avoid the following hazardous situations:

- drop-offs or holes
- bumps, floor obstructions, or debris
- sloped surfaces
- unstable or slippery surfaces
- overhead obstructions and high voltage conductors
- hazardous locations
- inadequate surface support to withstand all load forces imposed by the machine
- wind and weather conditions
- the presence of unauthorized personnel
- other possible unsafe conditions

Inspections

Inspection for Decals with Words

Determine whether the decals on your machine have words or symbols. Use the appropriate inspection to verify that all decals are legible and in place.

Below is a numerical list with quantities and descriptions.

Part No.	Decal Description	Qty
27204	Arrow – Blue	1
27205	Arrow – Yellow	1
27206	Triangle – Blue	2
27207	Triangle – Yellow	2
28159	Label – Diesel	1
28174	Label – Power to Platform, 230V	3
28235	Label – Power to Platform, 115V	3
28236	Warning – Improper Operation	1
31060	Danger – Tip-over Hazard, Limit Switch	4
31788	Danger – Explosion/Burn Hazard	1
38149	Label – Patent (US only)	1
44981	Label – Air Line to Platform (option)	2
52475	Label – Transport Tie Down	6
52865	Warning – Annual Inspection Record	1
65278	Caution – No Step	2
72086	Label – Lifting Point	4
72875	Warning – Pipe Cradle (option)	2
82237	Danger – Electrocution Hazard (option)	3
82366	Label – Chevron Rando	1
82410	Warning – Panel Cradle (option)	2
82862	Danger – Fire Extinguisher, Welder (option)	1
97548	Instructions – Deutz Engine Specifications (F3L 2011 & D2011 L03i)	1
97579	Danger – Tip-over Welder (option)	1
97602	Warning – Explosion Hazard	1
97815	Label – Lower Mid-rail	1
97865	Warning – Electrocution Hazard	1
114258	Danger – Explosion Hazard	2
114390	Danger – Electrocution Hazard	3
114416	Danger – Tip-over Hazard, Tilt Alarm	1
133250	Danger – Track Specifications	4
133278	Label – Low Sulfur Fuel	1
133310	Label – Engine Start & Controls Battery	1

Part No.	Decal Description	Qty
147792	Danger – Tire Specifications	4
218559	Danger, Warning – Tip-over, Crush Hazard	1
219487	Label – Platform Overload	1
826345	Label – Ultra Low Sulfur Fuel Only (diesel models)	1
1258949	Ground Control Panel	1
1263543	Warning – Compartment Access	2
1267121	Warning – Crush Hazard, Service	1
1272242	Label – Machine Registration/Owner Transfer	1
1278542	Label – Contact Alarm Weight	1
1278982	Label – Actuator Switch Socket	1
1279433	Platform Control Panel	1
1280819	Label – Warning, Prop 65	1
1280820	Label – Fuel, Diesel Exhaust, Prop 65	1
1281169	Label – Recovery Switch	1
1281174	Label – Lanyard Anchorage Point, Fall Arrest/Fall Restrained	8
1281180	Instructions – Operating Instructions	1
1281188	Label – Emergency Lowering	1
1283577	Label – Lift Power	1
1283744	Label – Lift Power	1
1284005	Instructions – Kubota Engine Specs, D1803-CR-TIE4	1
1284007	Label – Relay Fuse Panel, Kubota 48 HP	1
1284011	Label – Danger – Tip-over Hazard	1
1284013	Label – Transport and Lifting	2
1286361	Label – S-60 J Swing Lock	1
1293324	Label – ICES-2/CAN-2 Compliance	1
1294398	Label – ANSI/CSA Compliant	1
1294845	Label – Engine Catch Tray	1
1295407	Label – Relay Fuse Panel	1
1296503	Label – Wheel Load, S-80 J	4
1305444	Label – Fill level, Hydraulic. Tank	1
1305727	Instructions – Kubota Engine Specifications (D1803-CR)	1
1306312	Label – Loading, Trax, S-80 J	4
1309022	Label – Word, Runaway, 45%/20%/20%	1

 Shading indicates decal is hidden from view, i.e. under covers

* These decals are model, option or configuration specific.

Inspections

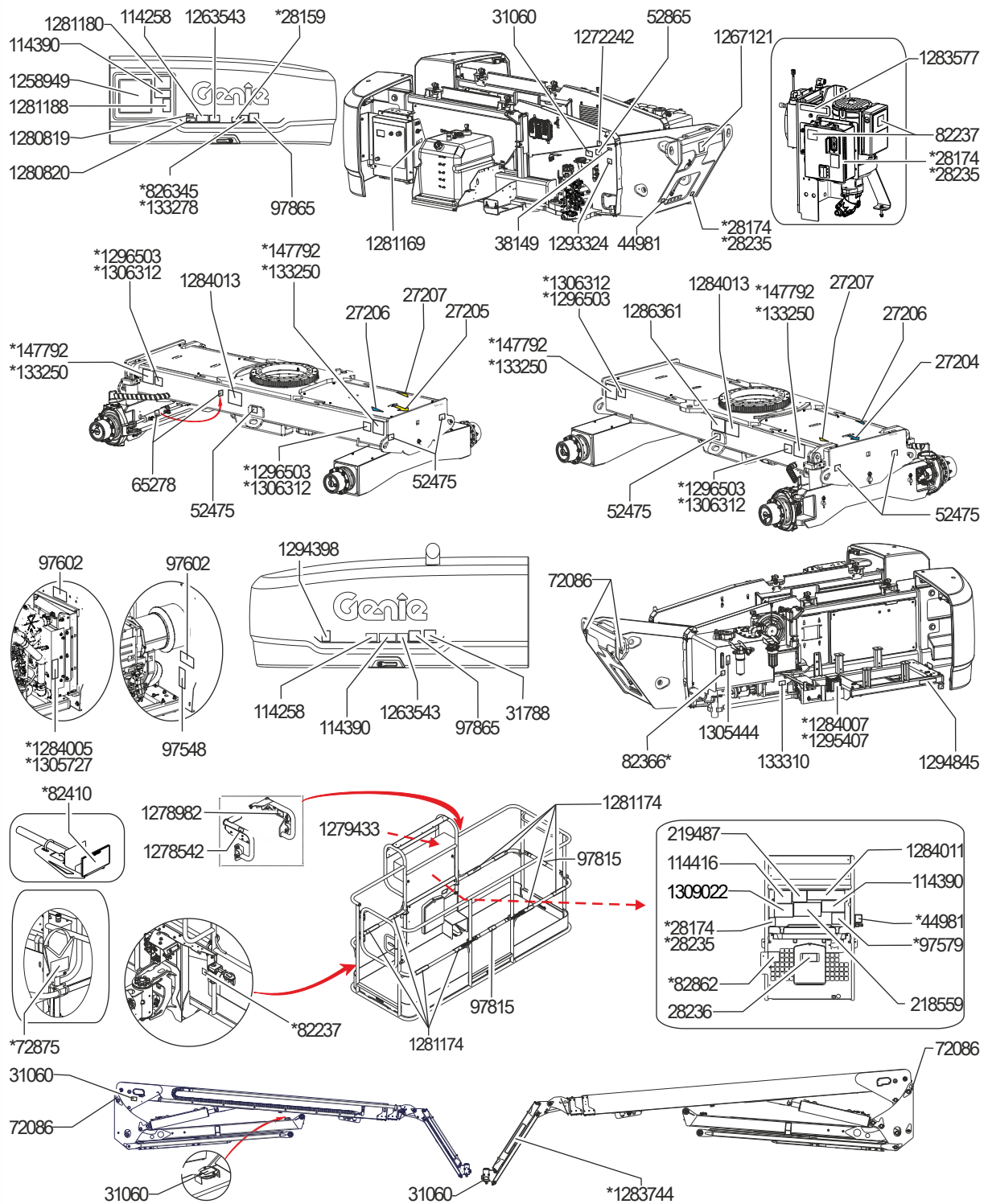

Inspections

Inspection for Decals with Symbols

Determine whether the decals on your machine have words or symbols. Use the appropriate inspection to verify that all decals are legible and in place.

Below is a numerical list with quantities and descriptions.

Part No.	Decal Description	Qty
27204	Arrow – Blue	1
27205	Arrow – Yellow	1
27206	Triangle – Blue	2
27207	Triangle – Yellow	2
28159	Label – Diesel	1
28174	Label – Power to Platform, 230V	3
28235	Label – Power to Platform, 115V	3
44981	Label – Air Line to Platform (option)	2
52475	Label – Transport Tie Down	6
65278	Caution – No Step	2
72086	Label – Lifting Point	4
82481	Label – Battery/Charger Safety	2
82487	Label – Read the Manual	2
82487	Label – Read the Manual (panel cradle)	2
82487	Label – Read the Manual (pipe cradle)	2
97815	Label – Lower Mid-rail	2
114249	Label – Tip-over Hazard, Tires	4
114251	Label – Explosion Hazard	2
114252	Label – Tip-over Hazard, Limit Switches	4
114473	Label – Tilt Alarm	1
133067	Label – Electrocutation Hazard	3
133205	Label – Electrocutation/Burn Hazard	2
133263	Label – Tracks Specifications	4
219956	Label – Platform Overload	1

Part No.	Decal Description	Qty
219958	Label – Tip-over, Crush Hazard	1
1256425	Label – Danger, Electrocutation Hazard	3
1258949	Ground Control Panel	1
1263542	Label – Compartment Access	2
1272242	Label – Machine Registration/Owner Transfer	1
1278542	Label – Contact Alarm Weight	1
1278982	Label – Actuator Switch Socket	1
1279433	Platform Control Panel	1
1281169	Label – Recovery Switch	1
1281174	Label – Lanyard Anchorage Point, Fall Arrest/Fall Restrained	8
1281188	Label – Emergency Lowering	1
1283577	Label – Lift Power	1
1283744	Label – Lift Power	1
1284007	Label – Relay Fuse Panel, Kubota 48 HP	1
1284012	Label – Danger – Tip-over Hazard	1
1284013	Label – Transport and Lifting	2
1286361	Label – S-60 J Swing Lock	1
1286362	Label – Crush Hazard, Service	1
1294398	Label – ANSI/CSA Compliant	1
1294845	Label – Engine Catch Tray	1
1295407	Label – Relay Fuse Panel	1
1296503	Label – Wheel Load, S-80 J	4
1304217	Label – Explosion Hazard	1
1305444	Label – Fill level, Hydraulic. Tank	1
1306312	Label – Loading, Trax, S-80 J	4
1309021	Label – Symbol, Runaway, 45%/20%/20%	1

 Shading indicates decal is hidden from view, i.e. under covers

* These decals are model, option or configuration specific.

Inspections

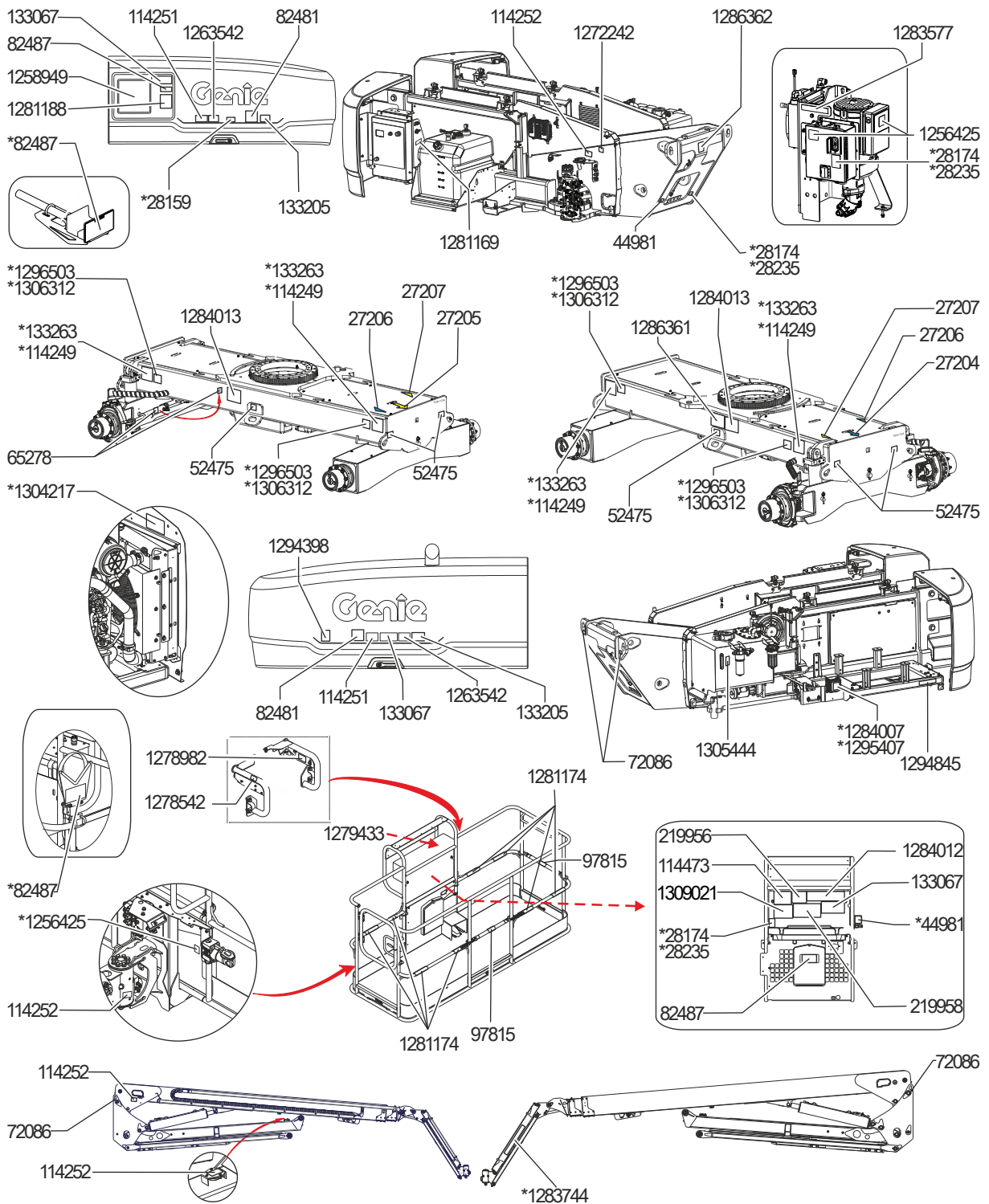

Operating Instructions

Pictures in this manual may show a boom with tires and wheels instead of tracks. All safety information and operating instructions still apply to the S-80 J TRAX, even if the picture does not show the tracks.



Do Not Operate Unless:

- You learn and practice the principles of safe machine operation contained in this operator's manual.
 - 1 Avoid hazardous situations.
 - 2 Always perform a pre-operation inspection.
 - 3 Always perform function tests prior to use.
 - 4 Inspect the workplace.
 - 5 **Only use the machine as it was intended.**

Fundamentals

The Operating Instructions section provides instructions for each aspect of machine operation. It is the operator's responsibility to follow all the safety rules and instructions in the operator's, safety, and responsibilities manuals.

Using the machine for anything other than lifting personnel, along with their tools and materials, to an aerial work site is unsafe and dangerous.

Only trained and authorized personnel should be permitted to operate a machine. If more than one operator is expected to use a machine at different times in the same work shift, they must all be qualified operators and are all expected to follow all safety rules and instructions in the operator's, safety, and responsibilities manuals. That means every new operator should perform a pre-operation inspection, function tests, and a workplace inspection before using the machine.

Operating Instructions

Starting the Engine

Diesel models

- 1 At the ground controls, turn the key switch to the desired position.
- 2 Be sure both ground and platform control red Emergency Stop buttons are pulled out to the on position.
The engine glow plugs will automatically start when the machine is turned on.
- 3 At the ground controls: The LCD screen will display the glow plug symbol when the automatic glow plugs are on.
- 4 At the platform controls: The glow plug indicator light will come on when the automatic glow plugs are on.
- 5 When the glow plugs turn off, start the engine. Move and hold the engine start toggle switch or press and hold the engine start button.
- 6 If the engine fails to start or dies, the restart delay will disable the start switch for 3 seconds.



Emergency Stop

Push in the red Emergency Stop button to the off position at the ground controls or the platform controls to stop all machine functions and turn the engine off.

Repair any function that operates when either red Emergency Stop button is pushed in.

Selecting and operating the ground controls will override the platform red Emergency Stop button.

Auxiliary Power

Use auxiliary power if the primary power source fails.

- 1 Turn the key switch to ground or platform control.
- 2 Pull out the red Emergency Stop button to the on position.
- 3 Press down the foot switch when using the controls from the platform.
- 4 Simultaneously hold the auxiliary power switch to either side and activate the desired function.



Note: The drive function will not operate with auxiliary power.

Operating Instructions

Operation from Ground

- 1 Turn the key switch to ground control.
- 2 Pull out the red Emergency Stop button to the on position.

The engine glow plugs will automatically start when the machine is turned on.

- 3 When the glow plugs turn off, start the engine.

To Position Platform

- 1 Push and hold the function enable button.



- 2 Push the appropriate function button according to the markings on the control panel.

Drive and steer functions are not available from the ground controls.

Platform Overload Indicator Light

Light flashing indicates the platform is overloaded. The engine will stop and no functions will operate.

Remove weight from the platform until the light goes off and then restart the engine.

Note: An alarm will sound at the platform when an overload condition occurs and will stop sounding when weight is removed from the platform.

Operating Instructions

Operation from Platform

- 1 Turn the key switch to platform control.
- 2 Pull out both ground and platform red Emergency Stop buttons to the on position.

The engine glow plugs will automatically start when the machine is turned on.

- 3 When the glow plugs turn off, start the engine. Do not press down the foot switch when starting the engine.

To Position Platform

- 1 Press down the foot switch.
- 2 Slowly move the appropriate function control handle or toggle switch or press the appropriate button according to the markings on the control panel.

To Steer

- 1 Press down the foot switch.
- 2 Slowly move the drive control handle in the direction indicated by blue or yellow triangles OR press the thumb rocker switch located on top of the drive control handle.

Use the color-coded direction arrows on the platform controls and the drive chassis to identify the direction the wheels will turn.

To Drive

- 1 Press down the foot switch.
- 2 Increase speed: Slowly move the control handle off center.

Decrease speed: Slowly move the control handle toward center.

Stop: Return the control handle to center or release the function enable switch.

Use the color-coded direction arrows on the platform controls and the drive chassis to identify the direction the machine will travel.

Machine travel speed is restricted when the boom is raised.

Platform Overload Indicator Light

Light flashing indicates the platform is overloaded. The engine will stop and no functions will operate.

Remove weight from the platform until the light goes off and then restart the engine.

Note: An alarm will sound at the platform when an overload condition occurs and will stop sounding when weight is removed from the platform.

Operating Instructions

▲ Driving on a slope

Determine the uphill, downhill and side slope ratings for the machine and determine the slope grade.



Maximum slope rating, platform downhill (gradeability):
4WD: 45% (24°)



Maximum slope rating, platform uphill:
4WD: 20% (11°)



Maximum side slope rating:
20% (11°)

Note: Slope rating is subject to ground conditions with one person in the platform and adequate traction. Additional platform weight may reduce slope rating. The term gradeability applies to the counterweight uphill configuration only.

Be sure the boom is below horizontal and the platform is between the non-steer wheels, or non-steer tracks.

Move the drive speed select switch to machine on incline symbol.

To determine the slope grade:

Measure the slope with a digital inclinometer OR use the following procedure.

You will need:

- carpenter's level
- straight piece of wood, at least 3 feet/1 m long
- tape measure

Lay the piece of wood on the slope.

At the downhill end, lay the level on the top edge of the piece of wood and lift the end until the piece of wood is level.

While holding the piece of wood level, measure the vertical distance from the bottom of the piece of wood to the ground.

Divide the tape measure distance (rise) by the length of the piece of wood (run) and multiply by 100.

Example:

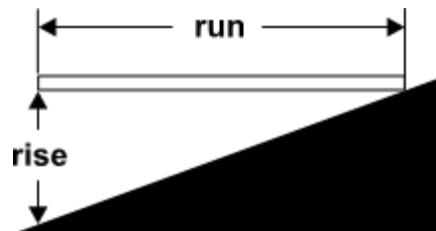

Piece of wood = 144 inches (3.6 m)

Run = 144 inches (3.6 m)

Rise = 12 inches (0.3 m)

$12 \text{ in} \div 144 \text{ in} = 0.083 \times 100 = 8.3\% \text{ grade}$

$0.3 \text{ m} \div 3.6 \text{ m} = 0.083 \times 100 = 8.3\% \text{ grade}$

If the slope exceeds the maximum slope or side slope rating, then the machine must be winched or transported up or down the slope. See Transport and Lifting section.

Operating Instructions

Rotating turntable on slope

Turntable rotate functions can be disabled when machine is on a slope greater than 10 degrees.

Return the machine to level ground to restore turntable rotate function.

Drive Enable

Light flashing indicates that the boom has moved just past either non-steer wheel and the drive function has been interrupted.



To drive, hold the drive enable switch to either side and slowly move the drive control handle off center.

Be aware that the machine may move in the opposite direction that the drive and steer controls are moved.

Always use the color-coded direction arrows on the platform controls and the drive chassis to identify the direction the machine will travel.

Drive Speed Select



- Machine on incline symbol: Low range operation for inclines or rough terrain
- Machine on level surface symbol: High range operation for maximum drive speed.

Engine RPM Select

Select engine RPM using the symbols on the control panel.

When the foot switch is not pressed, the engine will idle at the lowest rpm.

- Turtle symbol: Foot switch activated low speed
- Rabbit symbol: Foot switch activated high speed



Note: If rabbit symbol is selected, high RPM will not activate for platform functions.

Generator (if equipped)

To operate the generator, move the generator toggle switch to the on position.

Note: The generator indicator light will turn on.

The generator will turn on and the engine will continue to run in high RPM mode.

Plug a power tool into AC power outlet located at the platform, or turntable.

To stop the generator, move the generator toggle switch to the off position.

Note: The generator indicator light will turn off and the RPM will return to normal.

Operating Instructions

Machine Not Level Indicator Light (if equipped)



Machine On Incline indicator light is on: The light is on and the tilt alarm sounds when the machine exceeds the tilt sensor activation settings. Follow the appropriate procedure below and move the machine to a firm, level surface.



If the tilt alarm sounds with the platform uphill:

- 1 Lower the boom.
- 2 Retract the boom.



If the tilt alarm sounds with the platform downhill:

- 1 Retract the boom.
- 2 Lower the boom.

Platform Overload Indicator Light



Light flashing indicates the platform is overloaded. The engine will stop and no functions will operate.

Remove weight from the platform until the light goes off and then restart the engine.

Machine Malfunction Indicator Light



Light on indicates a system fault.

- 1 Push in and then pull out the red Emergency Stop button.
- 2 Lower and retract the boom.
- 3 Tag the machine and remove from service. Functions will not operate.

Operating Instructions

Tilt Sensor Activation Settings

Model	Chassis Angle
S-80 J S-80 J Trax	4.5°

When the Machine On Incline indicator light is on and the tilt alarm sounds, the following functions are affected; drive functions are disabled.



Follow the Boom lowering procedure (see Operating Instructions) to restore drive function.

When the machine is stowed, on a slope, and the tilt alarm sounds, the following functions are affected; lift functions are disabled.



Return the machine to level ground to restore lift functions.

LCD Screen

The LCD screen at the ground controls displays hour meter, voltage, oil pressure and coolant temperature. The screen also displays fault codes and other service information.

Contact Alarm (if equipped)

The contact alarm is designed to alert ground personnel when an operator makes contact with the platform control panel, interrupting boom movement, sounding an alarm and flashing warning lights.

When the contact alarm cable is tripped, the lift and drive functions are disabled at the platform. The audio and visual warnings will activate alerting others that assistance may be needed. These notifications will continue until the system is reset.

- 1 The contact alarm cable is tripped, releasing the actuator from the switch socket.
- 2 Insert the actuator into the switch socket to turn off flashing lights and audio alarm.

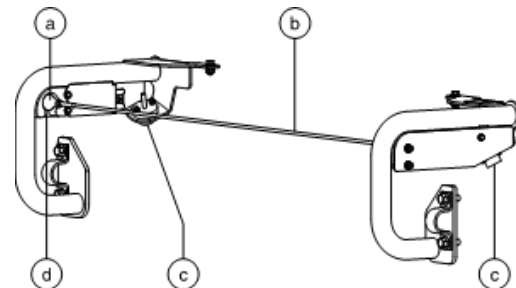

- a actuator
- b contact alarm cable
- c flashing alarm
- d switch socket

Operating Instructions

Aircraft Protection Package Operation (if equipped)

If the platform bumper comes into contact with an object, the machine will shut down and no functions will operate.

Aircraft Protection Override (Platform Controls)

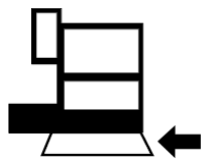

- 1 Move and hold the aircraft protection function override switch.
- 2 Move the appropriate function to move the platform away from the object.

Aircraft Protection Override (Ground Controls)

- 1 Release all functions, including the function enable button.



- 2 Press and hold the function enable button to override the protection.

- 3 Move the appropriate function to move the platform away from the object.

Pipe Cradle Instructions

The pipe cradle assembly consists of 2 pipe cradles positioned at either side of the platform and mounted to the guardrails with U-bolts.

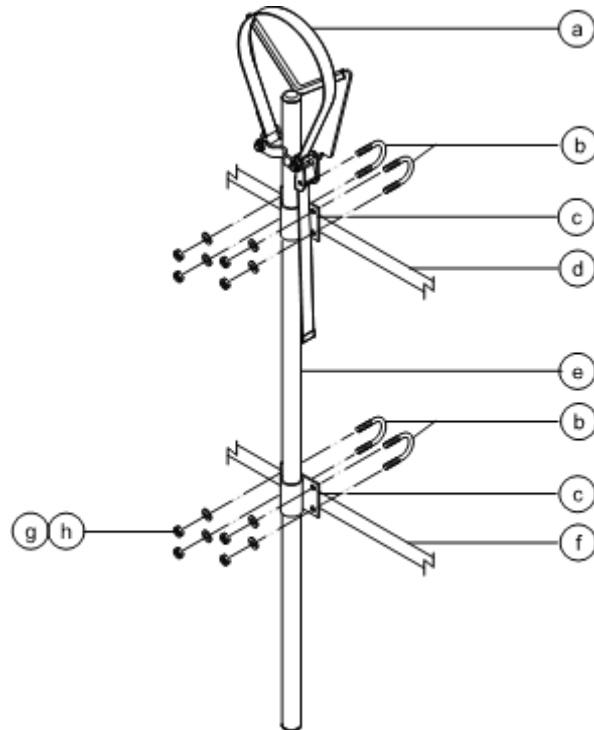

- a strap
- b U-bolts
- c pipe cradle mount
- d upper platform railing
- e pipe cradle weldment
- f middle platform railing
- g flat washers
- h nylock nuts

Operating Instructions

Observe and Obey:

- ☑ Pipe cradles must be installed on the inside of the platform.
- ☑ Pipe cradles must not obstruct the platform controls or the platform entrance.
- ☑ The bottom of the pipe cradle tube must rest on the platform floor.
- ☑ Be sure the platform is level before installing a pipe cradle.

Pipe Cradle Installation

- 1 Install a pipe cradle on each side of the platform. Refer to the illustration on the left. Make sure the bottom of the pipe cradle tube rests on the platform floor.
- 2 Install two U-bolts from the outside of the platform rails through each pipe cradle mount.
- 3 Secure each U-bolt with 2 washers and 2 nuts.

Pipe Cradle Operation

- 1 Be sure the pipe cradle assembly and installation instructions have been followed properly and that the pipe cradles are secured to the platform railings.
 - 2 Place the load so that it rests in both pipe cradles. The length of the load should be parallel with the length of the platform.
 - 3 Center the load in the pipe cradles.
 - 4 Secure the load to each pipe cradle. Pass the nylon strap over the load. Depress the buckle and slide the strap through. Tighten the strap.
 - 5 Gently push and pull on the load to make sure the pipe cradles and load are secure.
 - 6 Keep the load secured when the machine is moving.
- ▲ Tip-over hazard. The weight of the pipe cradle assembly and the load in the pipe cradles will reduce the rated platform capacity of the machine and must be factored into the total platform load.
- ▲ Tip-over hazard. The weight of the pipe cradle assembly and the load in the pipe cradles may limit the maximum number of occupants in the platform.

Maximum Pipe Cradle Capacity

All models	200 lbs 90.7 kg
Pipe Cradle Assembly Weight	21 lbs 9.5 kg

Operating Instructions

Panel Cradle Assembly

- 1 Apply the warning decal to the front of each panel cradle (if needed).
- 2 Install rubber bumper 1 in the panel cradle base. See the illustration.
- 3 Secure the bumper with 2 high profile lock nuts and 2 washers.

Panel Cradle Installation

- 1 Insert the hook piece through the slots in the panel cradle base.
- 2 Hook the panel cradle to the bottom platform tube in the desired location.
- 3 Install rubber bumper 2 through the panel cradle base and the hook piece. See the illustration.
- 4 Secure with 2 low profile lock nuts.
- 5 If the panel cradle is installed at a platform floor support tube, insert the U-bolt through the floor, around the tube and into the panel cradle base.
- 6 Secure the U-bolt with 2 nuts and 2 washers. Proceed to step 9.
- 7 If the panel cradle is not installed at a platform floor support tube, use the aluminum tube provided.
- 8 Place the tube between the panel cradle and the platform floor. Insert the U-bolt through the floor, around the tube and into the panel cradle base.
- 9 Repeat above for the second set of parts.

Installation of Padding

- 1 Install the 2 pieces of padding on the platform rails. Position the padding to protect the panels from contact with the platform rails.

Installation of Strap

- 1 Open the clamp and install it around a vertical platform rail tube.
- 2 Insert a bolt with a washer through one side of the clamp.
- 3 Install the strap assembly end plate onto the bolt.
- 4 Insert the bolt through the other side of the clamp.
- 5 Secure with a washer and a nut. Do not over-tighten. The strap assembly end plate should be able to slide on the platform rail.

Panel Cradle Operation

- 1 Secure both panel cradles to the platform.
- 2 Place the load so that it rests in both panel cradles.
- 3 Center the load on the platform.
- 4 Secure the load to the platform using the strap. Tighten the strap.

Operating Instructions

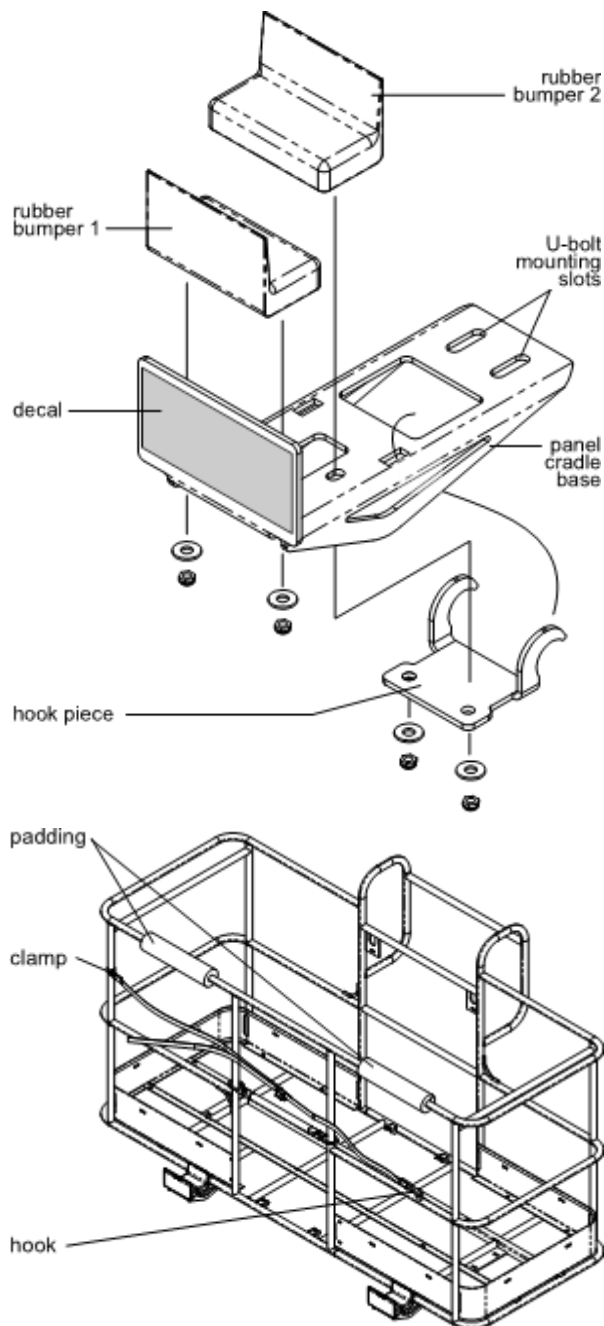

After Each Use

- 1 Select a safe parking location—firm level surface, clear of obstruction and traffic.
- 2 Retract and lower the boom to the stowed position.
- 3 Rotate the turntable so that the boom is between the non-steer wheels.
- 4 Turn the key switch to the off position and remove the key to secure from unauthorized use.

Machine Storage

Properly preparing and stowing the machine for extended storage will make it easier to put the machine back into service.

- 1 See After Each Use section for basic machine stowing instructions.
- 2 Store the machine in a dry and well-ventilated location. Be sure machine is clean and dry.
- 3 Perform a complete Pre-Operation Inspection.
Models with Engines: fill the fuel tank.
- 4 Refer to the Scheduled Maintenance section in the appropriate Service Manual, and complete each lubrication procedure.
- 5 Remove and store the battery.
- 6 Models with Engines: Refer to the OEM engine manual for additional extended storage procedures. As needed, start and run the engine for 10 minutes.

Transport and Lifting Instructions

Pictures in this manual may show a boom with tires and wheels instead of tracks. All safety information and operating instructions still apply to the S-80 J TRAX, even if the picture does not show the tracks.



Observe and Obey:

- ☑ Genie provides this securement information as a recommendation. Drivers are solely responsible for making sure machines are properly secured and the correct trailer is selected pursuant to US Department of Transportation regulations, other localized regulations, and their company policy.
- ☑ Genie customers needing to containerize any lift or Genie product should source a qualified freight forwarder with expertise in preparing, loading and securing construction and lifting equipment for international shipment.
- ☑ Only qualified mobile elevating work platform operators should move the machine on, or off the truck.
- ☑ The transport vehicle must be parked on a level surface.
- ☑ The transport vehicle must be secured to prevent rolling while the machine is being loaded.
- ☑ Be sure the vehicle capacity, loading surfaces and chains or straps are sufficient to withstand the machine weight. Genie lifts are very heavy relative to their size. See the serial label for the machine weight.
- ☑ Be sure the turntable is secured with the turntable rotation lock before transporting. Be sure to unlock the turntable for operation.
- ☑ Do not drive the machine on a slope that exceeds the uphill, downhill or side slope rating. See Driving on a Slope in the Operating Instructions section.
- ☑ If the slope of the transport vehicle bed exceeds the maximum slope rating, the machine must be loaded and unloaded using a winch as described in the brake release operation.

Free-wheel Configuration for Winching

Chock the wheels to prevent the machine from rolling.

Release the wheel brakes by turning over all four drive hub disconnect caps.

Be sure the winch line is properly secured to the drive chassis tie points and the path is clear of all obstructions.

Reverse the procedures described to re-engage the brakes.

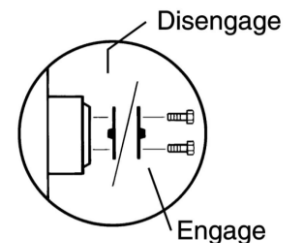

Transport and Lifting Instructions

Securing to Truck or Trailer for Transit

Always use the turntable rotation lock pin each time the machine is transported.

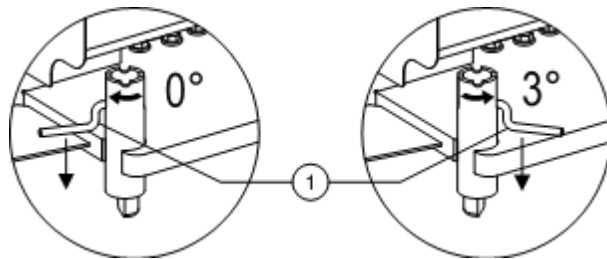

1 Turntable rotation lock pin

Turn the key switch to the off position and remove the key before transporting.

Inspect the entire machine for loose or unsecured items.

Note: Set the turntable rotation lock pin to 3° for efficient, multiple machine transportation.

Securing the Chassis

Use chains of ample load capacity.

Use a minimum of 6 chains.

Adjust the rigging to prevent damage to the chains.

For diagram, refer to the Lifting Instructions.

Securing the Platform

Place a block under the platform rotator. Do not allow the block to contact the platform cylinder.

Make sure the jib and platform are in the stowed position.

Secure the platform with a nylon strap placed parallel to the strap guides. Do not use excessive downward force when securing the boom section.

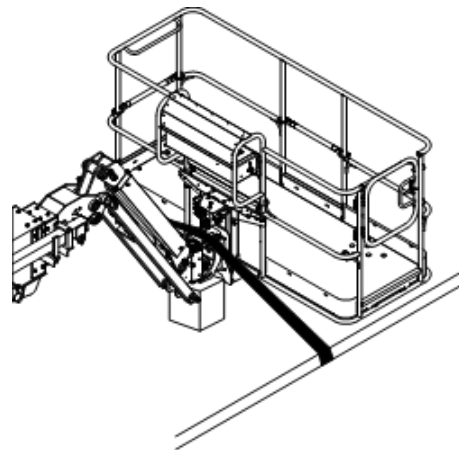

Transport and Lifting Instructions



Observe and Obey:

- ☑ Only qualified riggers should rig the machine.
- ☑ Only certified crane operators should lift the machine and only in accordance with the applicable crane regulations.
- ☑ Be sure the crane capacity, loading surfaces and straps or lines are sufficient to withstand the machine weight. See the serial label for the machine weight.

Lifting Instructions

Fully lower and retract the boom. Fully lower the jib.

Determine the center of gravity of your machine using the table and the picture on this page.

Attach the rigging only to the designated lifting points on the machine.

Adjust the rigging to prevent damage to the machine and to keep the machine level.

Center of gravity	X Axis	Y Axis
S-80 J	87 in 2.21 m	52 in 1.32 m
S-80 J Trax	84 in 2.13 m	52 in 1.32 m

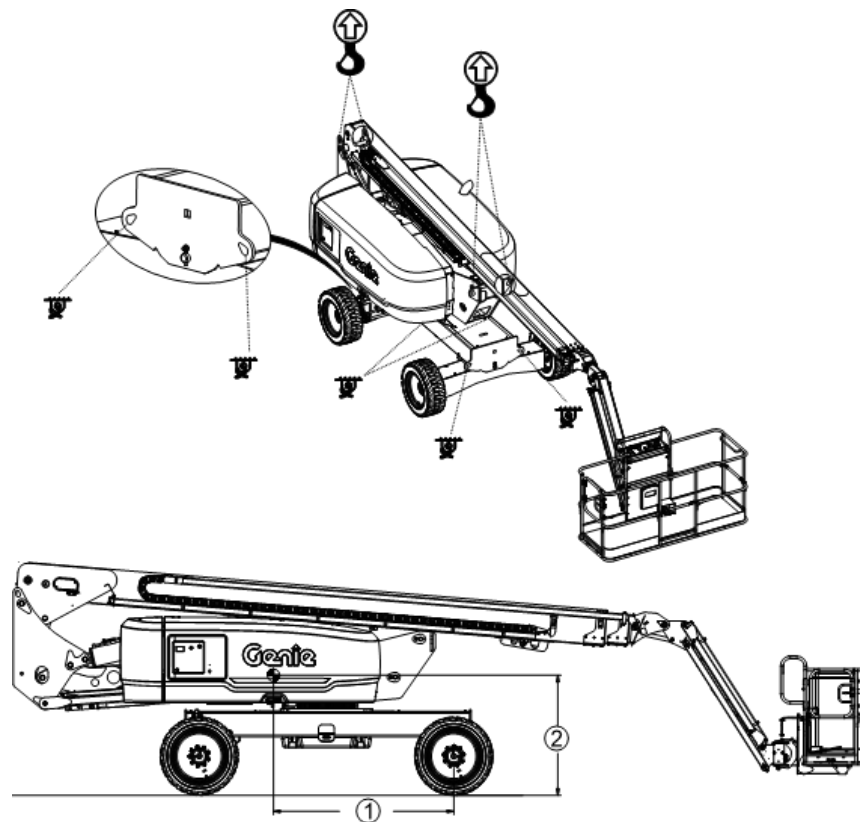

1 - X Axis

2 - Y Axis



Maintenance

Pictures in this manual may show a boom with tires and wheels instead of tracks. All safety information and operating instructions still apply to the S-80 J TRAX, even if the picture does not show the tracks.



Observe and Obey:

- Only routine maintenance items specified in this manual shall be performed by the operator.
- Scheduled maintenance inspections shall be completed by qualified service technicians, according to the manufacturer's specifications and the requirements specified in the responsibilities manual.
- Use only Genie approved replacement parts.

Maintenance Symbols Legend

The following symbols have been used in this manual to help communicate the intent of the instructions. When one or more of the symbols appear at the beginning of a maintenance procedure, it conveys the meaning below.



Indicates that tools will be required to perform this procedure.



Indicates that new parts will be required to perform this procedure.



Indicates that a cold engine is required before performing this procedure.

Check the Engine Oil Level



Maintaining the proper engine oil level is essential to good engine performance and service life. Operating the machine with an improper oil level can damage engine components.

Note: Check the oil level with the engine off.

- 1 Check the oil level dipstick. Add oil as needed.

Deutz D2011 L03i Engine

Oil type	15W-40
----------	--------

Oil type - cold conditions	5W-30
----------------------------	-------

Kubota D1803-CR-TIE4 Kubota D1803-CR-TE5B

Oil type	10W-30 or 10W-40
----------	---------------------

Maintenance

Diesel Fuel Requirements



Satisfactory engine performance is dependent on the use of a good quality fuel. The use of a good quality fuel will give the following result: long engine life and acceptable exhaust emissions levels.

Minimum diesel fuel requirements for each engine are listed below.

Deutz D2011 L03i Engine

Fuel Type	Low Sulfur Diesel (LSD)
-----------	-------------------------

Kubota D1803-CR-TIE4 Kubota D1803-CR-TE5B

Fuel Type	Ultra Low Sulfur Diesel (ULSD)
-----------	--------------------------------

Check the Hydraulic Oil Level



Maintaining the hydraulic oil at the proper level is essential to machine operation. Improper hydraulic oil levels can damage hydraulic components. Daily checks allow the inspector to identify changes in oil level that might indicate the presence of hydraulic system problems.

- 1 Be sure that the boom is in the stowed position.
- 2 Visually inspect the sight gauge located on the side of the hydraulic oil tank.
- ⊙ Result: The hydraulic oil level should be within the specified range as indicated by the decal.
- 3 Add oil as needed. Do not overfill.

Hydraulic oil specifications

Hydraulic oil type	Chevron Rando HD equivalent
--------------------	-----------------------------

Maintenance

Check the Engine Coolant Level – Liquid Cooled Models



Maintaining the engine coolant at the proper level is essential to engine service life. Improper coolant level will affect the engine's cooling capability and damage engine components. Daily checks will allow the inspector to identify changes in coolant level that might indicate cooling system problems.

- ▲ Burn hazard. Beware of hot engine parts and coolant. Contact with hot engine parts and/or coolant may cause severe burns.
 - ▲ Burn hazard. Do not remove the radiator cap if the engine has been running. Contact with pressurized coolant may cause severe burns. Allow engine to cool before removing the radiator cap.
- 1 Check the fluid level in the coolant recovery tank. Add fluid as needed.
- ⊙ Result: The fluid level should be at the FULL mark on the tank or visible in the sight gauge.

Check the Batteries



Proper battery condition is essential to good machine performance and operational safety. Improper fluid levels or damaged cables and connections can result in component damage and hazardous conditions.

- ▲ Electrocution hazard. Contact with hot or live circuits may result in death or serious injury. Remove all rings, watches and other jewelry.
 - ▲ Bodily injury hazard. Batteries contain acid. Avoid spilling or contacting battery acid. Neutralize battery acid spills with baking soda and water.
- 1 Put on protective clothing and eye wear.
 - 2 Be sure that the battery cable connections are tight and free of corrosion.
 - 3 Be sure that the battery hold-down brackets are in place and secure.

Note: Adding terminal protectors and a corrosion preventative sealant will help eliminate the corrosion on the battery terminals and cables.

Maintenance

Scheduled Maintenance

Maintenance performed commissioning, quarterly, annually and every two years must be completed by a person trained and qualified to perform maintenance on this machine according to the procedures found in the service and maintenance manuals for this machine.

Machines that have been out of service for more than three months must receive the quarterly inspection before they are put back into service.

Obey all local and governmental regulations regarding the disposal and decommissioning of the machine at the end of its lifetime. Refer to the appropriate Genie service manual for additional information.

Specifications

Model	S-80 J	
	S-80 J Trax	
Height, working maximum	86 ft 5 in	26.51 m
Height, platform maximum	80 ft 5 in	24.51 m
Horizontal reach, platform maximum	54 ft 9 in	16.69 m
Below Grade Reach	2 ft 2 in	0.66 m
Maximum load capacity	660 lbs	300 kg
Maximum wind speed	28 mph	12.5 m/s
Platform rotation	160°	
Platform leveling	self-leveling	
Jib rotation	130° (+75°, -55°)	
Turntable rotation (degrees)	353°	
Turntable tailswing	8 ft 4 in	2.54 m
Turntable tailswing, Boom Raised	4 ft 2 in	1.27 m
Height, stowed maximum	9 ft	2.74 m
Length, stowed, Working	34 ft 3 in	10.44 m
Length, stowed, Jib Stowed	26 ft 2 in	7.98 m
Width, standard tires	8 ft 2 in	2.49 m
Width, Trax	8 ft 4 in	2.54 m
Wheelbase	10 ft	3.05 m
Ground clearance, center, Tires	14 in	35.6 cm
Ground clearance, center, Trax	16.25 in	41 cm
Ground clearance, middle, Tires	13.75 in	34.9 cm
Ground clearance, axle (End), Tires	9.5 in	24.13 cm
Turning radius (inside), Tires	10ft 10 in	3.3 m
Turning radius (inside), Trax	15 ft 10 in	4.83 m
Turning radius (outside), Tires	21 ft 8 in	6.6m
Turning radius (outside), Trax	24 ft	7.32 m
Platform dimensions, 6 foot (length x width)	72 in x 30 in	183 cm x 76 cm
Platform dimensions, 8 foot (length x width)	96 in x 36 in	244 cm x 91 cm
Weight, Tires	25,000 lb	11,340 Kg
Weight, Trax	29,200 lb	13,245 Kg

(Machine weights vary with option configurations. See serial label for specific machine weight.)

Ambient operating temperature	-20° F to 120° F -29° C to 49° C	
Controls	12V DC proportional	
AC outlet in platform	Standard	
System voltage	12V	
Hydraulic pressure, maximum (boom functions)	3,200 psi	220 bar
Tire size	355/55D 625	
Fuel tank capacity	30 gallons	113.5 liters
Hydraulic tank capacity	23 gallons	87 liters

Maximum slope rating, stowed position, 4WD

Platform uphill	45% (24°)
Platform downhill	20% (11°)
Side slope	20% (11°)

Note: Slope rating is subject to ground conditions with one person in the platform and adequate traction. Additional platform weight may reduce slope rating.

Maximum allowable chassis inclination Refer to "Tilt Sensor Activation Settings" section

Drive speeds, Tires

Drive speed, stowed	3.0 mph	4.8 km/h
	40 ft/9.1 sec	12.2 m/9.1 sec
Drive speed, raised or extended	0.72 mph	1.16 km/h
	40 ft/38 sec	12.2 m/38 sec

Drive speeds, Trax

Drive speed, stowed	1.95 mph	3.14 km/h
	40 ft/14 sec	12.2 m/14 sec
Drive speed, raised or extended	0.72 mph	1.16 km/h
	40 ft/38 sec	12.2 m/38 sec

Floor loading information, Tires

Tire load maximum	13,600 lbs	6,169 kg
Tire contact pressure	91 psi	6.40 kg/cm ² 627 kPa
Occupied floor pressure	243 psf	1,184 kg/m ² 11.61 kPa

Floor loading information, Trax

Track load maximum	14,900 lbs	6759 kg
Track contact pressure	25 psi	1.76 kg/cm ² 172 kPa
Occupied floor pressure	242 psf	1183 kg/m ² 11.60 kPa

Note: Floor loading information is approximate and does not incorporate different option configurations. It should be used only with adequate safety factors.

Continuous improvement of our products is a Genie policy. Product specifications are subject to change without notice or obligation.



Specifications

Pictures in this manual may show a boom with tires and wheels instead of tracks. All safety information and operating instructions still apply to the S-80 J TRAX, even if the picture does not show the tracks.

Range of Motion Chart - S-80 J and S-80 J TRAX

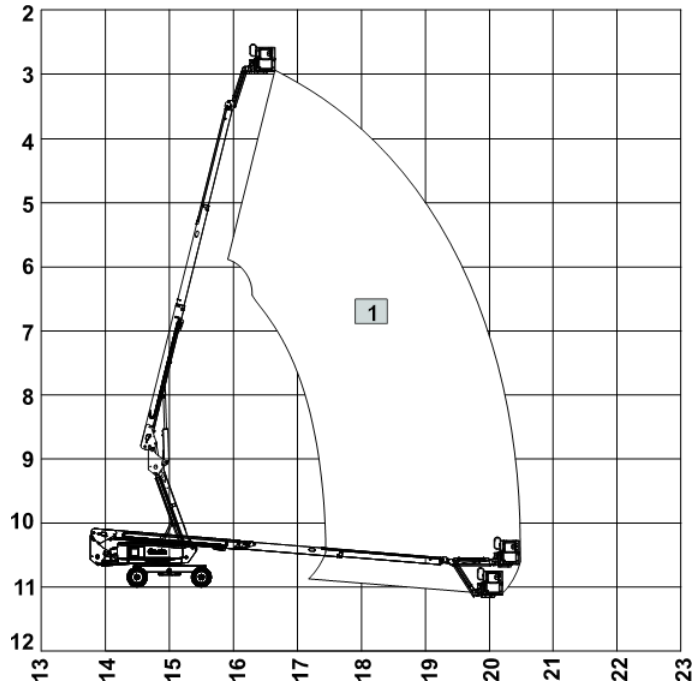

Maximum Platform Capacity

1	660 lbs	300 kg
---	---------	--------

Vertical Values

2	90 ft	27.4 m
3	80 ft	24.4 m
4	70 ft	21.34 m
5	60 ft	19.29 m
6	50 ft	15.24 m
7	40 ft	12.19 m
8	30 ft	9.14 m
9	20 ft	6.1 m
10	10 ft	3.05 m
11	0 ft	0 m
12	-10 ft	-3.05 m

Horizontal Values

13	-20 ft	-6.1 m
14	-10 ft	-3.05 m
15	0 ft	0 m
16	10 ft	3.05 m
17	20 ft	6.1 m
18	30 ft	9.14 m
19	40 ft	12.19 m
20	50 ft	15.24 m
21	60 ft	19.29 m
22	70 ft	21.34 m
23	80 ft	24.4 m



California Proposition 65



Operating, servicing and maintaining this equipment can expose you to chemicals including engine exhaust, carbon monoxide, phthalates, and lead, which are known to the State of California to cause cancer and birth defects or other reproductive harm. These chemicals can be emitted from or contained in other various parts and systems, fluids and some component wear by-products. To minimize exposure, avoid breathing exhaust, do not idle the engine except as necessary, service your equipment and vehicle in a well-ventilated area and wear gloves or wash your hands frequently when servicing your equipment or vehicle and after operation. For more information go to www.P65Warnings.ca.gov/passenger-vehicle.

Breathing diesel engine exhaust exposes you to chemicals known to the State of California to cause cancer and birth defects or other reproductive harm.

- Always start and operate the engine in a well-ventilated area.
- If in an enclosed area, vent the exhaust to the outside.
- Do not modify or tamper with the exhaust system.
- Do not idle the engine except as necessary.

For more information go to www.P65warnings.ca.gov/diesel.