



Operator's Manual

Serial Number Range

Z[®]-34/22N
Z[®]-34/22DC

from Z34NF-17000
from Z34ND-1900
from Z34F-14000

ANSI/CSA
North America
South America
Asia

with
Maintenance
Information

Original Instructions
Seventh Edition
Second Printing
Part No. 1297935GT

Contents

Introduction	1
Symbol and Hazard Pictorials Definitions.....	5
General Safety	8
Personal Safety.....	12
Work Area Safety.....	13
Legend	21
Controls.....	22
Inspections.....	24
Operating Instructions.....	40
Transport and Lifting Instructions	48
Maintenance	51
Specifications.....	53

Copyright © 1996 Terex Corporation

Seventh Edition: Second Printing, January 2023

Genie and "Z" are registered trademarks of Terex South Dakota, Inc. in the U.S.A. and many other countries.

These machines comply with
ANSI A92.20
CSA B354.6



Introduction

About this manual

Genie appreciates your choice of our machine for your application. Our number one priority is user safety, which is best achieved by our joint efforts. This book is an operation and daily maintenance manual for the user or operator of a Genie machine.

This manual should be considered a permanent part of your machine and should remain with the machine at all times. If you have any questions, contact Genie.

Product Identification

The machine serial number is located on the serial label.

Serial number stamped on chassis Serial label (located under cover)

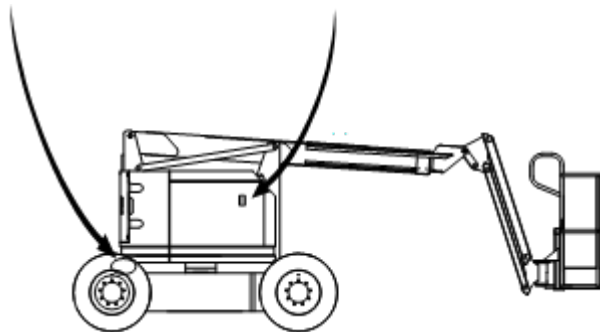

Intended Use and Familiarization Guide

The intended use of this machine is to lift personnel, including tools, and materials to an aerial work site. Before operating the machine, it's the operator's responsibility to read and understand this familiarization guide.

- Each person must be trained to operate a Mobile Elevating Work Platform (MEWP).
- Familiarization with the MEWP must be given to each person who is authorized, competent and trained.
- Only trained and authorized personnel should be permitted to operate the machine.
- The operator is responsible to read, understand, and obey the manufacturer's instructions and safety rules provided in the Operator's Manual.
- The Operator's Manual is located in the manual storage container, at the platform.
- For specific product applications, see **Contacting The Manufacturer**.

Introduction

Platform controls symbology and related machine movement:

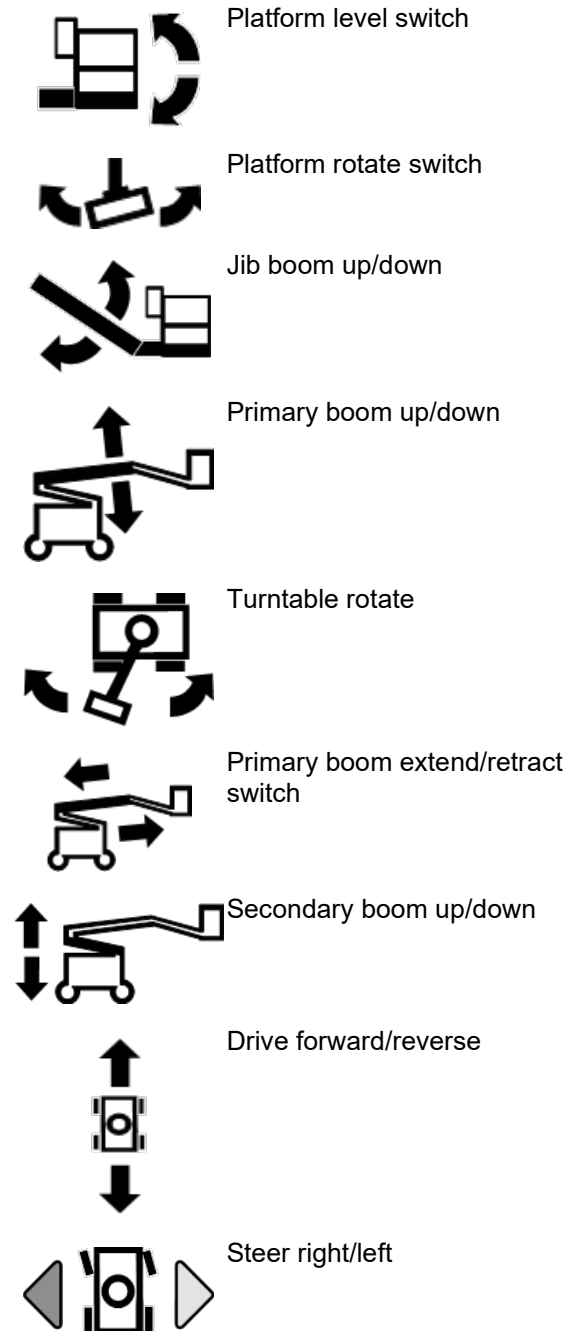

Ground controls symbology and related machine movement:

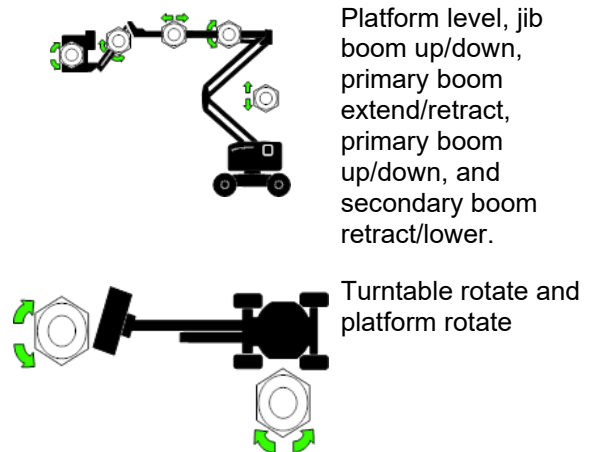

Sequential functions and movement:

- Drive and steer.

Interlocked functions:

- Elevated drive speed.
- Elevated lift and drive in an off-level condition.
- Drive enable when the boom is rotated past the non-steer wheels.
- All platform and ground controls.

Limitations of use:

- The intended use of this machine is to lift personnel, including tools, and materials to an aerial work site.
- Do not elevate the platform unless the machine is on firm level ground.

Stability enhancing means:

- Foam filled tires.

Restricted operating envelope:

- 500 lbs/227 kg platform capacity.

Introduction

Bulletin Distribution and Compliance

Safety of product users is of paramount importance to Genie. Various bulletins are used by Genie to communicate important safety and product information to dealers and machine owners.

The information contained in the bulletins is tied to specific machines using the machine model and serial number.

Distribution of bulletins is based on the most current owner on record along with their associated dealer, so it is important to register your machine and keep your contact information up to date.

To ensure safety of personnel and the reliable continued operation of your machine, be sure to comply with the action indicated in a respective bulletin.

Contacting the Manufacturer

At times it may be necessary to contact Genie. When you do, be ready to supply the model number and serial number of your machine, along with your name and contact information. At minimum, Genie should be contacted for:

Accident reporting

Questions regarding product applications and safety

Standards and regulatory compliance information

Current owner updates, such as changes in machine ownership or changes in your contact information. See Transfer of Ownership, below.

Transfer of Machine Ownership

Taking a few minutes to update owner information will ensure that you receive important safety, maintenance and operating information that applies to your machine.

Please register your machine by visiting us on the web at www.genielift.com or by calling us toll free at 1-800-536-1800.

Introduction



Danger

Failure to obey the instructions and safety rules in this manual will result in death or serious injury.

Do Not Operate Unless:

- You learn and practice the principles of safe machine operation contained in this operator's manual.
 - 1 Avoid hazardous situations.**

Know and understand the safety rules before going on to the next section.

 - 2 Always perform a pre-operation inspection.
 - 3 Always perform function tests prior to use.
 - 4 Inspect the workplace.
 - 5 Only use the machine as it was intended.
- You read, understand and obey the manufacturer's instructions and safety rules—safety and operator's manuals and machine decals.
- You read, understand and obey employer's safety rules and worksite regulations.
- You read, understand and obey all applicable governmental regulations.
- You are properly trained to safely operate the machine.

Safety Sign Maintenance

Replace any missing or damaged safety signs. Keep operator safety in mind at all times. Use mild soap and water to clean safety signs. Do not use solvent-based cleaners because they may damage the safety sign material.

Hazard Classification

Decals on this machine use symbols, color coding, and signal words to identify the following:



Safety alert symbol—used to alert you to potential personal injury hazards. Obey all safety messages that follow this symbol to avoid possible injury or death.



Indicates a hazardous situation which, if not avoided, will result in death or serious injury.



Indicates a hazardous situation which, if not avoided, could result in death or serious injury.















Indicates a hazardous situation which, if not avoided, could result in minor or moderate injury.



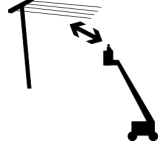

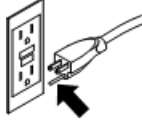

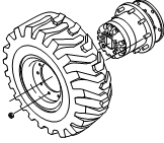



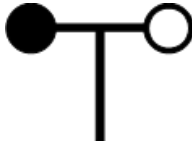
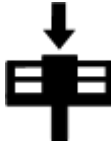



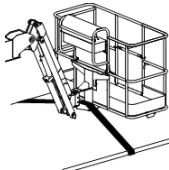
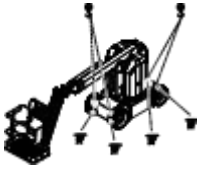

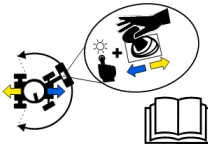
Indicates a property damage message.



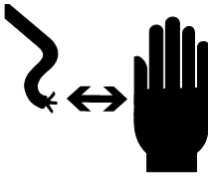



Symbol and Hazard Pictorials Definitions

 <p>Fire hazard</p>	 <p>Explosion hazard</p>	 <p>Explosion hazard</p>	 <p>Do not use ether or other high energy starting aids on machines equipped with glow plugs.</p>	 <p>No smoking. No flame. Stop engine.</p>
 <p>Crush hazard</p>	 <p>No smoking</p>	 <p>Explosion hazard</p>	 <p>Electrocution hazard</p>	 <p>Maintain required clearance</p>
 <p>Tip-over hazard</p>	 <p>Tip-over hazard</p>	 <p>Grounded AC 3-wire only</p>	 <p>Replace damaged wires and cords</p>	 <p>Replace tires with tires of same specification.</p>

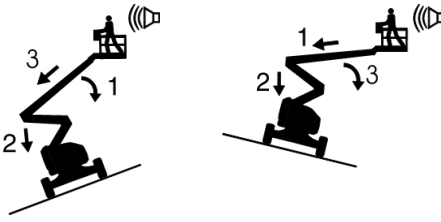
Symbol and Hazard Pictorials Definitions

 <p>Wheel load</p>	 <p>Wind speed</p>	 <p>Maximum capacity</p>	 <p>Manual force</p>	 <p>Batteries used as counterweights</p>
 <p>Tie-down point</p>	 <p>Lifting point</p>	 <p>Platform tie-down instructions</p>	 <p>Lifting and tie down instructions</p>	 <p>Lanyard anchorage points</p>
 <p>Corrosive acid.</p>	 <p>Color coded direction arrows</p>	 <p>Runaway hazard</p>	 <p>Collision hazard</p>	 <p>Collision hazard</p>
 <p>Electrocution hazard</p>	 <p>Avoid contact</p>	 <p>Disconnect battery</p>	 <p>Voltage rating for power to platform</p>	 <p>Pressure rating for air line to platform</p>

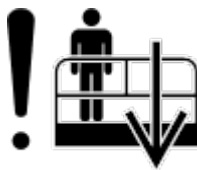
Symbol and Hazard Pictorials Definitions

<p>Recovery procedure if tilt alarm sounds while elevated.</p> 				
<p>Platform uphill: 1 Lower primary. 2 Lower secondary. 3 Retract primary.</p>	<p>Platform downhill: 1 Retract primary. 2 Lower secondary. 3 Lower primary.</p>	<p>Read the operator's manual</p>	<p>Read the service manual</p>	<p>Access by trained and authorized personnel only</p>
				
<p>Support the platform or boom during maintenance</p>	<p>Auxiliary lowering</p>	<p>Platform overloaded</p>	<p>Crush hazard</p>	

General Safety

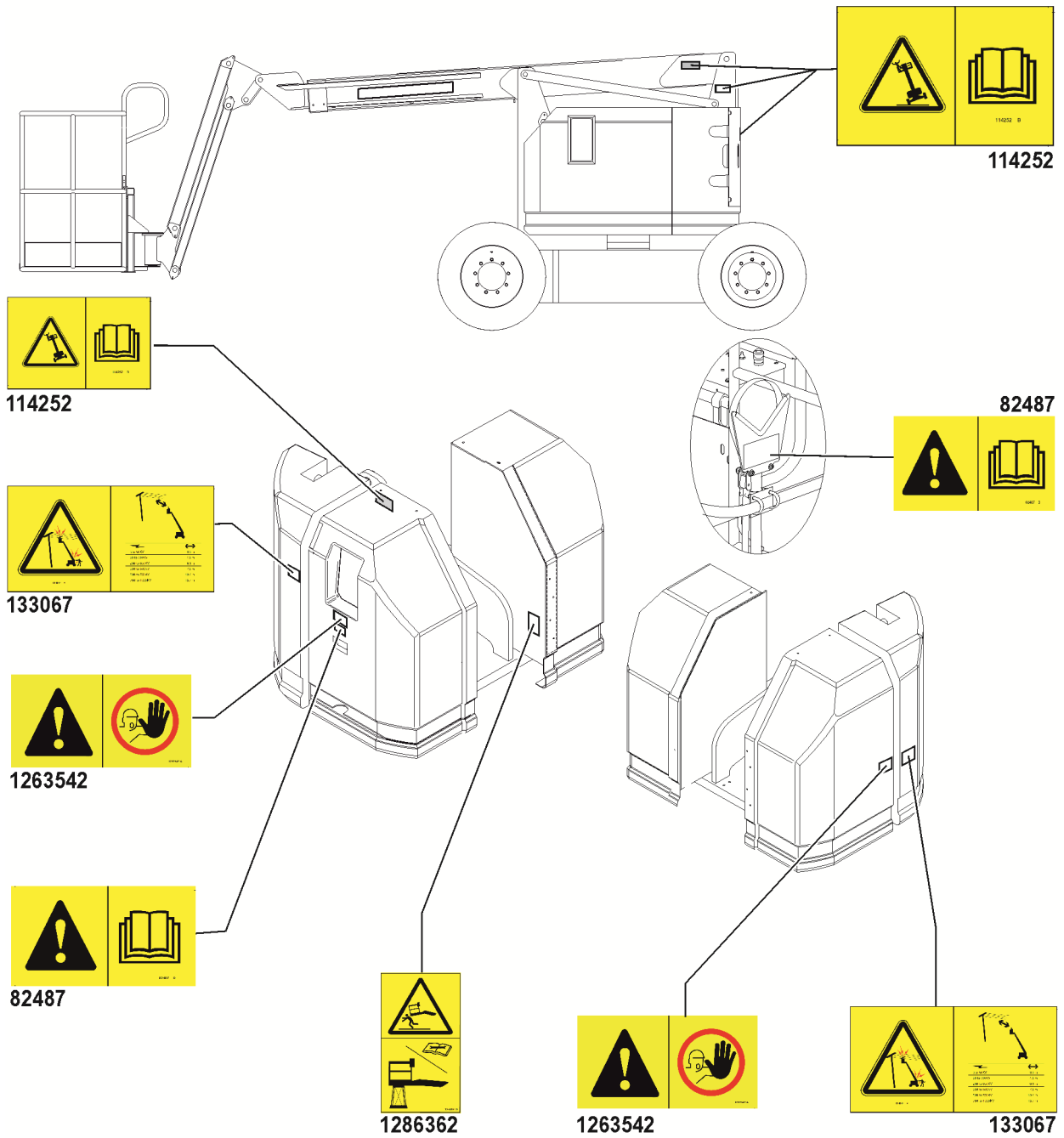

General Safety

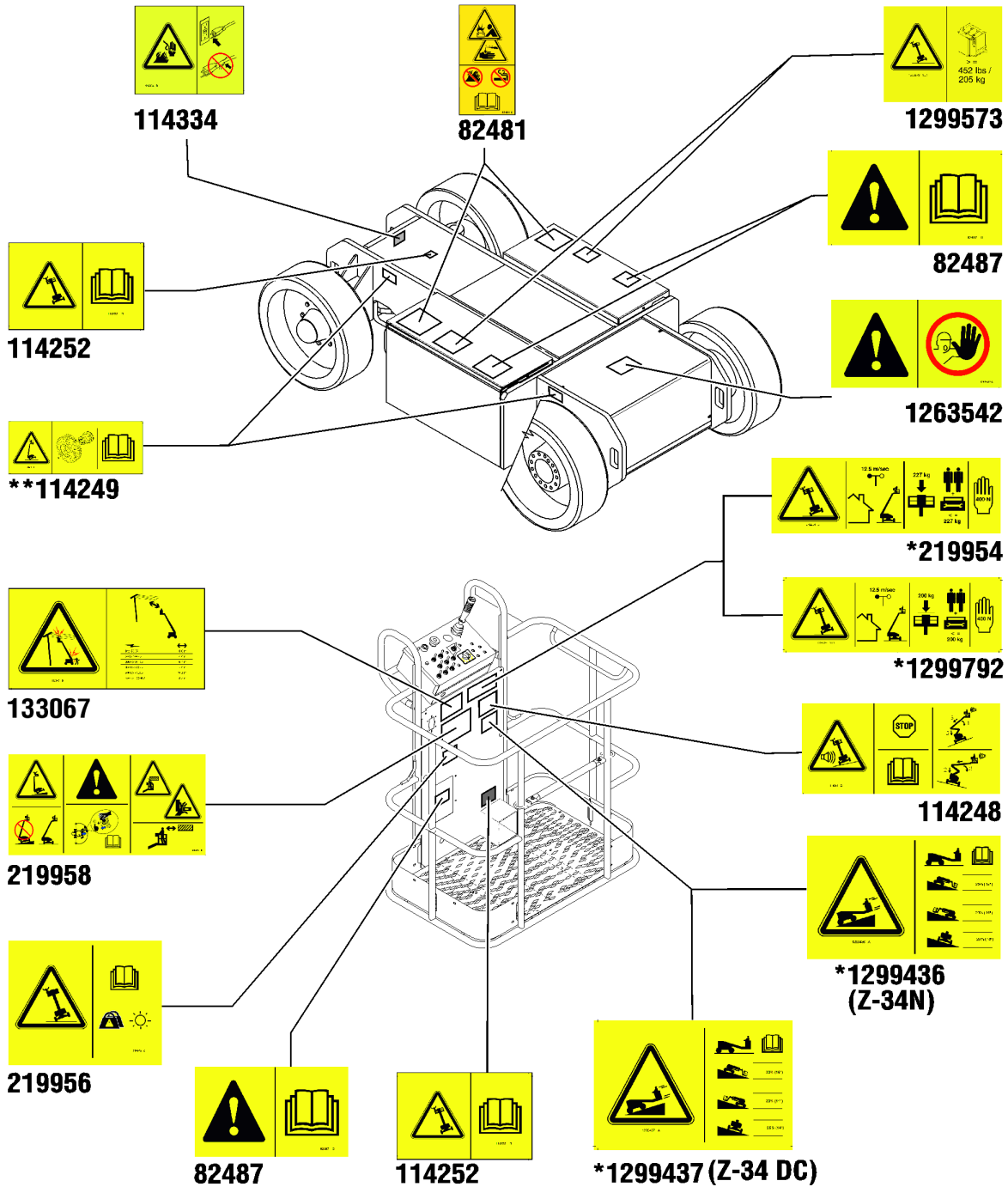

* These decals are model, option or configuration specific.

** These decals are installed on both sides of chassis.



Personal Safety

Personal Fall Protection

Personal fall protection equipment (PFPE) is required when operating this machine.

Occupants must wear a safety belt or harness in accordance with governmental regulations. Attach the lanyard to the anchor provided in the platform.

Operators must comply with employer, job site and governmental rules regarding the use of personal protective equipment.

All PFPE must comply with applicable governmental regulations, and must be inspected and used in accordance with the PFPE manufacturer's instructions.

Work Area Safety

⚠ Electrocuting Hazards

This machine is not electrically insulated and will not provide protection from contact with or proximity to electrical current.



Maintain safe distances from electrical power lines and apparatus in accordance with applicable governmental regulations and the following chart.

Voltage Phase to Phase	Minimum Safe Approach Distance	
0 to 300V	Avoid Contact	
300V to 50KV	10 ft	3.05 m
50KV to 200KV	15 ft	4.60 m
200KV to 350KV	20 ft	6.10 m
350KV to 500KV	25 ft	7.62 m
500KV to 750KV	35 ft	10.67 m
750KV to 1000KV	45 ft	13.72 m

Allow for platform movement, electrical line sway or sag, and beware of strong or gusty winds.

Keep away from the machine if it contacts energized power lines. Personnel on the ground or in the platform must not touch or operate the machine until energized power lines are shut off.

Do not operate the machine during lightning or storms.

Do not use the machine as a ground for welding.

⚠ Tip-over Hazards

Occupants, equipment and materials shall not exceed the maximum platform capacity.

Maximum platform capacity	500 lbs	227 kg
Machine equipped with Aircraft Protection Package	440 lbs	200 kg
Maximum occupants	2	

The weight of options and accessories, such as pipe cradles, panel cradles and welders, will reduce the rated platform capacity and must be subtracted from the platform capacity. See the decals with the options and accessories.

Do not use air-filled tires. These machines are equipped with foam-filled tires. Wheel weight and proper counterweight configuration are critical to stability.

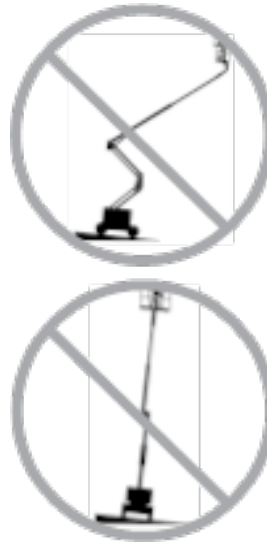

Do not raise or extend the boom unless the machine is on a firm, level surface.

Work Area Safety

Do not depend on the tilt alarm as a level indicator. The tilt alarm sounds in the platform only when the machine is on a severe slope.

If the tilt alarm sounds while the boom is lowered: Do not extend, rotate or raise the boom above horizontal. Move the machine to a firm, level surface before raising the platform.

If the tilt alarm sounds when the platform is raised, use extreme caution. Identify the condition of the boom on the slope as shown below. Follow the steps to lower the boom before moving to a firm, level surface. Do not rotate the boom while lowering.

If the tilt alarm sounds with the platform uphill:

- 1 Lower the primary boom.
- 2 Lower the secondary boom.
- 3 Retract the primary boom.

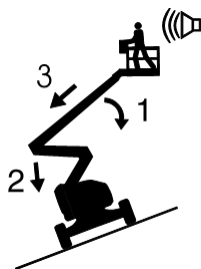

If the tilt alarm sounds with the platform downhill:

- 1 Retract the primary boom.
- 2 Lower the secondary boom.
- 3 Lower the primary boom.

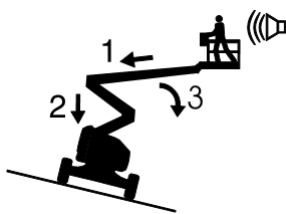

Do not alter or disable the limit switches.

Do not drive over 0.7 mph/1 km/h with the primary boom raised or extended or the secondary boom raised.

Do not use the platform controls to free a platform that is caught, snagged, or otherwise prevented from normal motion by an adjacent structure. All personnel must be removed from the platform before attempting to free the platform using the ground controls.

Do not raise the boom when wind speeds may exceed 28 mph/12.5 m/s. If wind speeds exceed 28 mph/12.5 m/s when the boom is raised, lower the boom and do not continue to operate the machine.



Do not operate the machine in strong or gusty winds. Do not increase the surface area of the platform or the load. Increasing the area exposed to the wind will decrease machine stability.



Use extreme care and slow speeds while driving the machine in the stowed position across uneven terrain, debris, unstable or slippery surfaces and near holes and drop-offs.

Do not drive the machine on or near uneven terrain, unstable surfaces or other hazardous conditions with the boom raised or extended.

Work Area Safety



Do not push off or pull toward any object outside of the platform.

Maximum allowable manual force - 90 lbs/400 N

Do not alter or disable machine components that in any way affect safety and stability.

Do not replace items critical to machine stability with items of different weight or specification.

Do not modify or alter a mobile elevating work platform without prior written permission from the manufacturer. Mounting attachments for holding tools or other materials onto the platform, toeboards, or guard rail system can increase the weight in the platform and the surface area of the platform or the load.



Do not place or attach fixed or overhanging loads to any part of this machine.



Do not place ladders or scaffolds in the platform or against any part of this machine.

Do not transport tools and materials unless they are evenly distributed and can be safely handled by person(s) in the platform.

Do not use the machine on a moving or mobile surface or vehicle.

Be sure the tires are in good condition and the lug nuts tightened.

Do not use batteries that weigh less than the original equipment. Batteries are used as counterweight and are critical to machine stability. Each battery must weigh a minimum of 88 lbs/40 kg. Each battery box including batteries must weigh a minimum of 452 lbs/205 kg.

Do not use the machine as a crane.

Do not push the machine or other objects with the boom.

Do not contact adjacent structures with the boom.

Do not tie the boom or platform to adjacent structures.

Do not place loads outside the platform perimeter.

Work Area Safety

⚠ Operation on Slopes Hazards

Do not drive the machine on a slope that exceeds the maximum uphill, downhill or side slope rating of the machine. Slope rating applies only to machines in the stowed position.

Z-34/22N, Maximum slope rating, stowed position

Platform downhill	35%	(19°)
Platform uphill	20%	(11°)
Side slope	25%	(14°)

Z-34/22 DC, Maximum slope rating, stowed position

Platform downhill	30%	(17°)
Platform uphill	20%	(11°)
Side slope	25%	(14°)

Note: Slope rating is subject to ground conditions with one person in the platform and adequate traction. Additional platform weight may reduce slope rating. See Driving on a Slope in the Operating Instructions section.

⚠ Fall Hazards

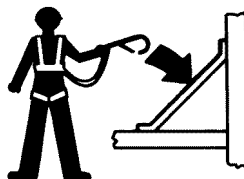

Occupants must wear a safety belt or harness in accordance with governmental regulations. Attach the lanyard to the anchor provided in the platform.



Do not sit, stand, or climb on the platform guard rails. Maintain a firm footing on the platform floor at all times.



Do not climb down from the platform when raised.

Keep the platform floor clear of debris.

Lower the platform entry mid-rail or close the entry gate before operating.

Do not enter or exit the platform unless the machine is in the stowed position and the platform is at ground level.

Hazards related with the specific product application of exiting at height have been considered in the design of the machine, for further information contact Genie (see section Contacting the Manufacturer).

Work Area Safety

▲ Collision Hazards

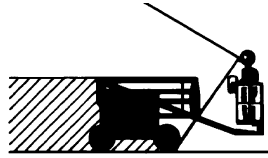

Be aware of limited sight distance and blind spots when driving or operating.

Be aware of the boom position and tailswing when rotating the turntable.



Check the work area for overhead obstructions or other possible hazards.



Be aware of crushing hazards when grasping the platform guard rail.

Operators must comply with employer, job site, and governmental rules regarding use of personal protective equipment.

Observe and use the color-coded direction arrows on the platform controls and drive chassis for drive and steer functions.



Do not lower the boom unless the area below is clear of personnel and obstructions.



Limit travel speed according to the condition of the ground surface, congestion, slope, location of personnel, and any other factors which may cause collision.

Do not operate a boom in the path of any crane unless the controls of the crane have been locked out and/or precautions have been taken to prevent any potential collision.

No stunt driving or horseplay while operating a machine.

Work Area Safety

▲ Bodily Injury Hazard

Do not operate the machine with a hydraulic oil or air leak. An air leak or hydraulic leak can penetrate and/or burn skin.

Improper contact with components under any cover will cause serious injury. Only trained maintenance personnel should access compartments. Access by the operator is only advised when performing a pre-operation inspection. All compartments must remain closed and secured during operation.

▲ Explosion and Fire Hazards

Charge the battery only in an open, well-ventilated area away from sparks, flames and lighted tobacco.

Do not operate the machine in hazardous locations or locations where potentially flammable or explosive gases or particles may be present.

▲ Damaged Machine Hazards

Do not use a damaged or malfunctioning machine.

Conduct a thorough pre-operation inspection of the machine and test all functions before each work shift. Immediately tag and remove from service a damaged or malfunctioning machine.

Be sure all maintenance has been performed as specified in this manual and the appropriate Genie service manual.

Be sure all decals are in place and legible.

Be sure the operator's, safety, and responsibilities manuals are complete, legible, and in the storage container located on the machine.

▲ Component Damage Hazards

Do not use the machine as a ground for welding.

Work Area Safety

⚠ Battery Safety

Burn Hazards

Batteries contain acid. Always wear protective clothing and eye wear when working with batteries.



Avoid spilling or contacting battery acid. Neutralize battery acid spills with baking soda and water.

The battery pack must remain in the upright position.

Do not expose the batteries or the charger to water or rain during charging.

Explosion Hazards



Keep sparks, flames, and lighted tobacco away from batteries. Batteries emit explosive gas.

The battery pack covers should remain open during the entire charging cycle.

Do not contact the battery terminals or the cable clamps with tools that may cause sparks.

⚠ Component Damage Hazard

Do not use any battery charger greater than 48V to charge the batteries.

Both battery packs must be charged together.

Disconnect the battery pack plug before removing the battery pack.

⚠ Electrocutation Hazard



Connect the battery charger to a grounded, AC 3-wire electrical outlet only.

Inspect daily for damaged cords, cables and wires. Replace damaged items before operating.

Avoid electrical shock from contact with battery terminals. Remove all rings, watches and other jewelry.

⚠ Tip-over Hazard

Do not use batteries that weigh less than the original equipment. Batteries are used as counterweight and are critical to machine stability. Each battery must weigh a minimum of 88 lbs/40 kg. Each battery box including batteries must weigh a minimum of 452 lbs/205 kg.

⚠ Lifting Hazard

Use a forklift to remove or install a battery pack.

Work Area Safety

▲ Contact Alarm Safety

Read, understand and obey all warnings and instructions provided with the contact alarm.

Do not exceed the rated platform capacity. The weight of the contact alarm assembly will reduce the rated platform capacity and must be subtracted from the total platform load.

The contact alarm assembly weighs 10 lbs/4.5 kg.

Be sure the contact alarm is securely installed.

Lockout After Each Use

- 1 Select a safe parking location—firm level surface, clear of obstruction and traffic.
- 2 Retract and lower the boom to the stowed position.
- 3 Rotate the turntable so that the boom is between the non-steer wheels.
- 4 Turn the key switch to the off position and remove the key to secure from unauthorized use.

Legend

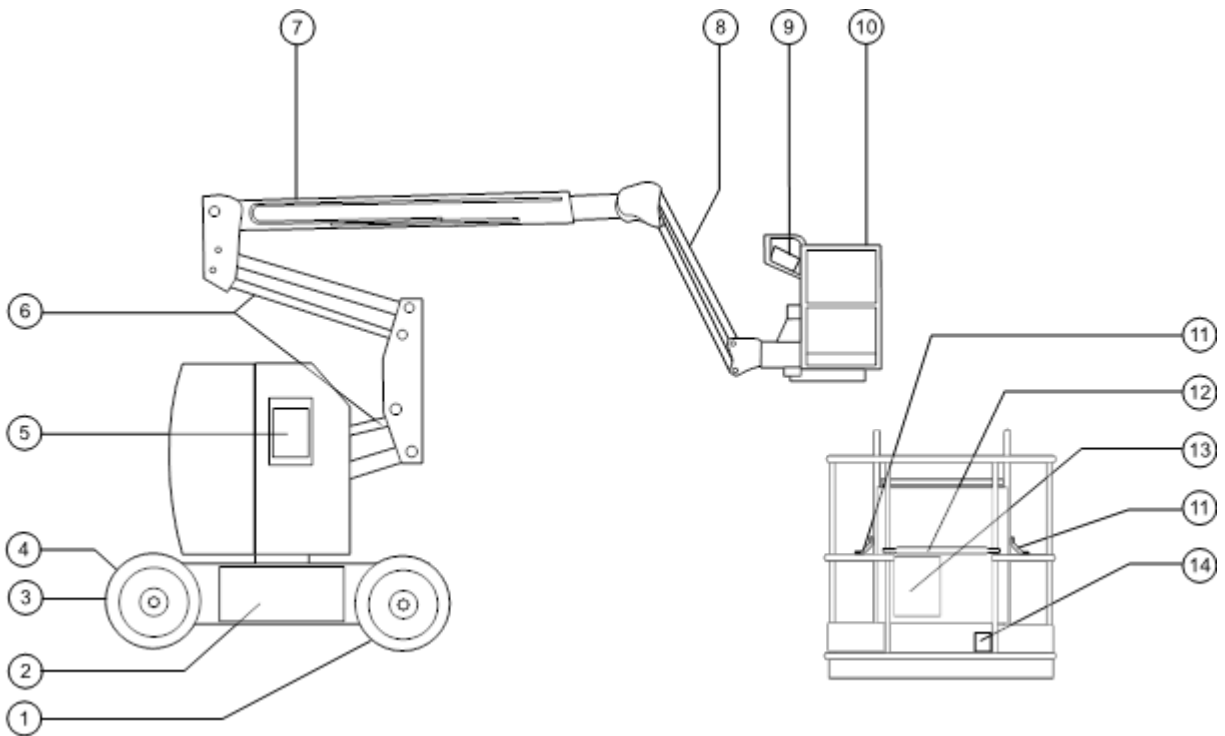

- | | |
|--|-----------------------------|
| 1 Non-steer tire | 8 Jib boom |
| 2 Battery box | 9 Platform controls |
| 3 Steer tire | 10 Platform |
| 4 Power to charger (between steer tires) | 11 Lanyard anchorage points |
| 5 Ground controls | 12 Sliding mid-rail |
| 6 Secondary boom | 13 Manual storage container |
| 7 Primary boom | 14 Foot switch |

Controls

The ground control station is to be used as a means to raise the platform for storage purposes and for function tests. The ground control station can be used in the event of an emergency to rescue an incapacitated person in the platform. When the ground control station is selected, the platform controls are inoperable, including the E-stop switch.

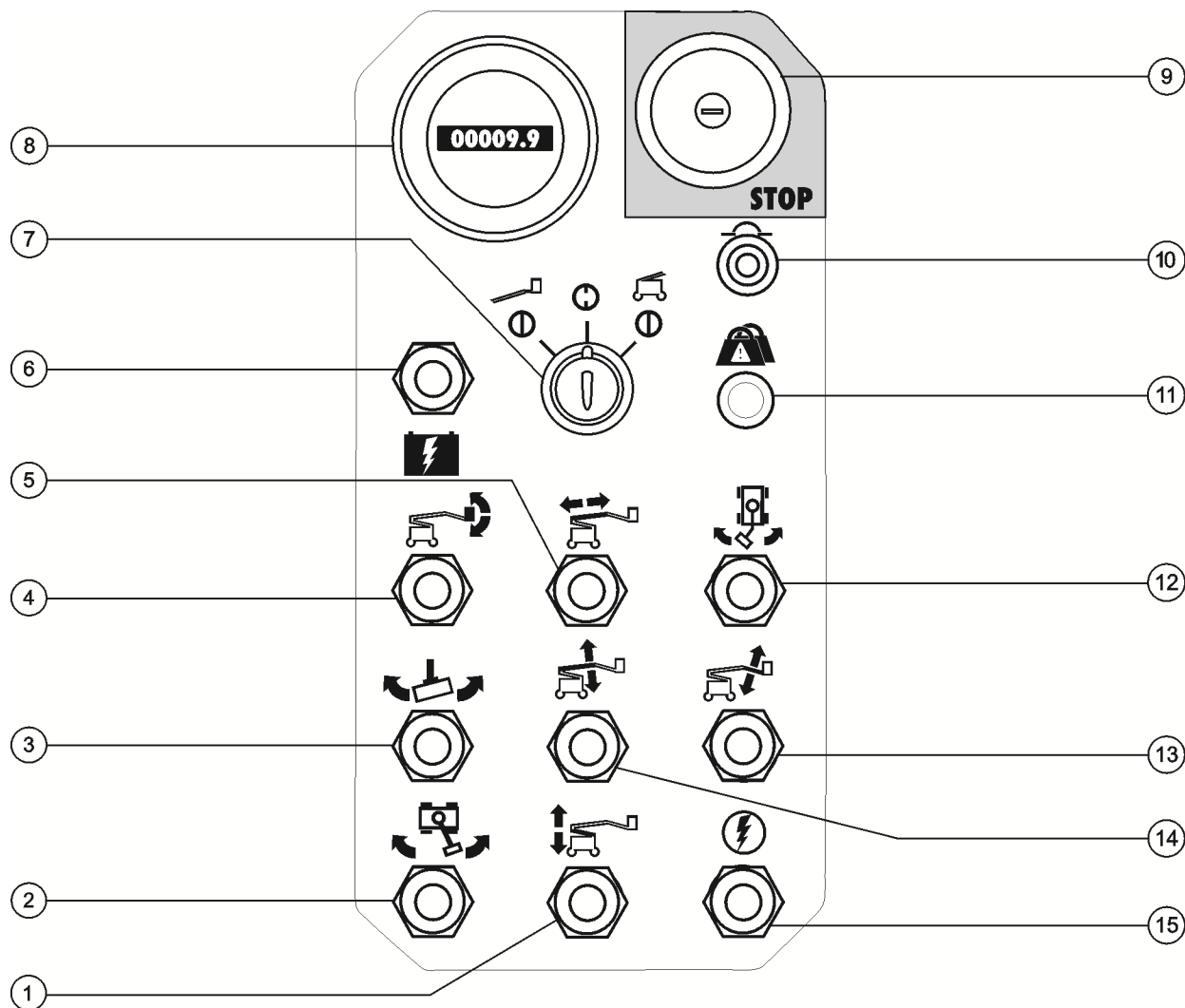

Ground Control Panel

- | | |
|--|--|
| 1 Secondary boom up/down switch | 8 Hour meter |
| 2 Turntable rotate switch | 9 Red Emergency Stop button |
| 3 Platform rotate switch | 10 10A breaker for control electrical circuits |
| 4 Platform level switch | 11 Platform overload indicator light |
| 5 Primary boom extend/retract switch | 12 Jib boom rotate switch (if equipped) |
| 6 Auxiliary power switch | 13 Jib boom up/down switch |
| 7 Key switch for platform/off/ground selection | 14 Primary boom up/down switch |
| | 15 Function enable switch |



Controls

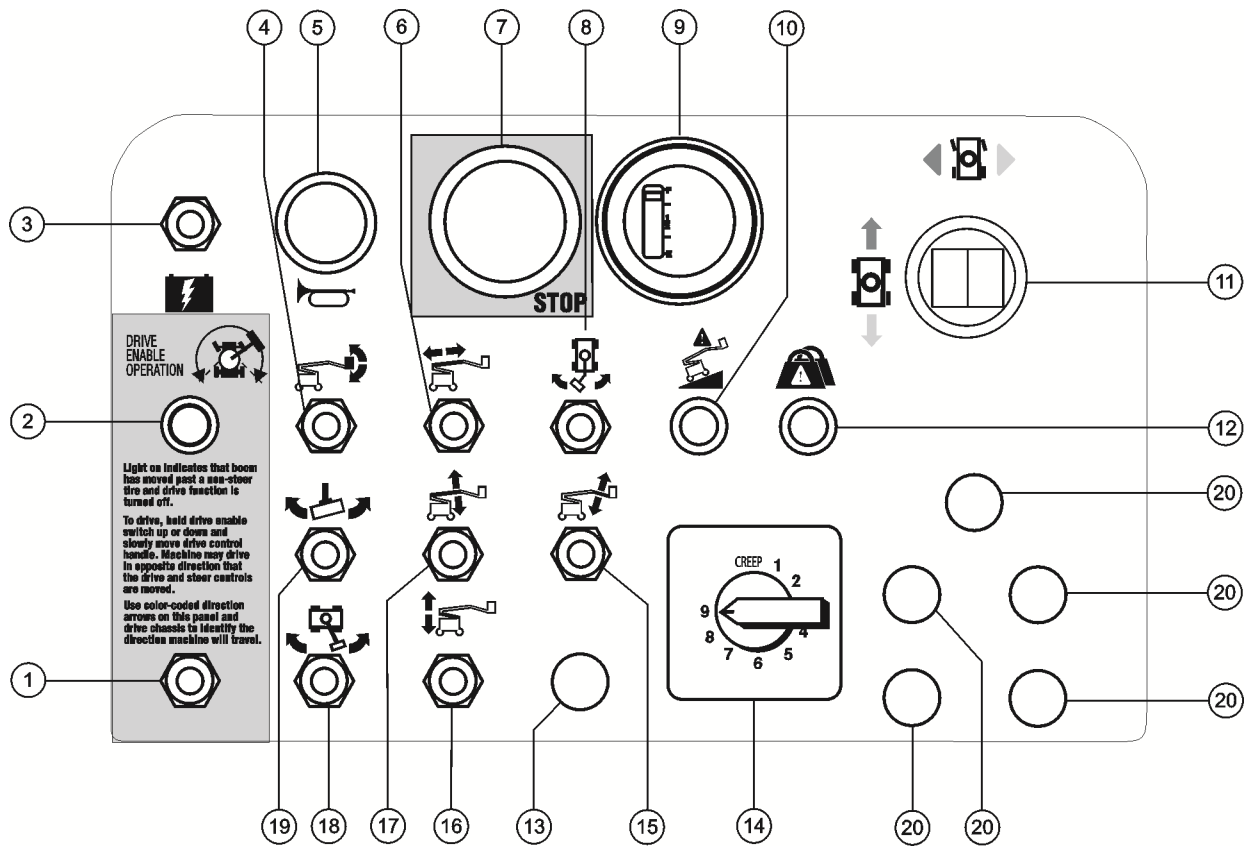

Platform Control Panel

- | | |
|--|--|
| <ul style="list-style-type: none"> 1 Drive enable switch 2 Drive enable indicator light 3 Auxiliary power switch 4 Platform level switch 5 Horn button 6 Primary boom extend/retract switch 7 Red Emergency Stop button 8 Jib boom rotate switch (if equipped) 9 Battery charge indicator and/or low voltage interrupt (option) 10 Machine not level indicator light (if equipped) | <ul style="list-style-type: none"> 11 Proportional control handle for drive function and thumb rocker for steer function 12 Platform overload indicator light (if equipped) 13 Function Override - Aircraft Protection Package (if equipped) 14 Boom function speed controller 15 Jib boom up/down switch 16 Secondary boom up/down switch 17 Primary boom up/down switch 18 Turntable rotate switch 19 Platform rotate switch 20 Not used |
|--|--|



Inspections



Do Not Operate Unless:

- You learn and practice the principles of safe machine operation contained in this operator's manual.
 - 1 Avoid hazardous situations.
 - 2 Always perform a pre-operation inspection.**
- Know and understand the pre-operation inspection before going on to the next section.**
 - 3 Always perform function tests prior to use.
 - 4 Inspect the workplace.
 - 5 Only use the machine as it was intended.

Pre-operation Inspection Fundamentals

It is the responsibility of the operator to perform a pre-operation inspection and routine maintenance.

The pre-operation inspection is a visual inspection performed by the operator prior to each work shift. The inspection is designed to discover if anything is apparently wrong with a machine before the operator performs the function tests.

The pre-operation inspection also serves to determine if routine maintenance procedures are required. Only routine maintenance items specified in this manual may be performed by the operator.

Refer to the list on the next page and check each of the items.

If damage or any unauthorized variation from factory delivered condition is discovered, the machine must be tagged and removed from service.

Repairs to the machine may only be made by a qualified service technician, according to the manufacturer's specifications. After repairs are completed, the operator must perform a pre-operation inspection again before going on to the function tests.

Scheduled maintenance inspections shall be performed by qualified service technicians, according to the manufacturer's specifications and the requirements listed in the responsibilities manual.

Inspections

Pre-operation Inspection

- Be sure that the operator's, safety and responsibilities manuals are complete, legible and in the storage container located in the platform.
- Be sure that all decals are legible and in place. See Decals section.
- Check for hydraulic oil leaks and proper oil level. Add oil if needed. See Maintenance section.
- Check for battery fluid leaks and proper fluid level. Add distilled water if needed. See Maintenance section.

Check the following components or areas for damage, improperly installed, or missing parts and unauthorized modifications:

- Electrical components, wiring, and electrical cables
- Hydraulic power unit, reservoir, hoses, fittings, cylinders and manifolds
- Drive and turntable motors and drive hubs
- Wear pads
- Tires and wheels
- Limit switches and horn
- Contact alarm (if equipped)
- Beacons and alarms (if equipped)
- Nuts, bolts and other fasteners
- Platform entry mid-rail or gate
- Platform load cell
- Lanyard anchorage points

Check entire machine for:

- Cracks in welds or structural components
- Dents or damage to machine
- Excessive rust, corrosion or oxidation
- Verify that all structural and other critical components are present and all associated fasteners and pins are in place and properly tightened.
- Be sure that both battery packs are in place and properly connected.
- After you complete your inspection, be sure that all compartment covers are in place and latched.

Inspections



Do Not Operate Unless:

- You learn and practice the principles of safe machine operation contained in this operator's manual.
 - 1 Avoid hazardous situations.
 - 2 Always perform a pre-operation inspection.
 - 3 Always perform function tests prior to use.**

Know and understand the function tests before going on to the next section.

- 4 Inspect the workplace.
- 5 Only use the machine as it was intended.

Function Test Fundamentals

The function tests are designed to discover any malfunctions before the machine is put into service. The operator must follow the step-by-step instructions to test all machine functions.

A malfunctioning machine must never be used. If malfunctions are discovered, the machine must be tagged and removed from service. Repairs to the machine may only be made by a qualified service technician, according to the manufacturer's specifications.

After repairs are completed, the operator must perform a pre-operation inspection and function tests again before putting the machine into service.

Inspections

At the Ground Controls

- 1 Select a test area that is firm, level and free of hazards.
- 2 Turn the key switch to ground control.
- 3 Pull out the red Emergency Stop button to the on position.
- 4 Result: The beacon (if equipped) should flash.

Test Emergency Stop

- 5 Push in the ground red Emergency Stop button to the off position.
- ⊙ Result: No functions should operate.
- 6 Pull out the red Emergency Stop button to the on position.

Test the Boom Functions

- 7 Do not hold the function enable switch to either side. Attempt to activate each boom and platform function toggle switch. 
- ⊙ Result: No boom and platform functions should operate.
- 8 Hold the function enable switch to either side and activate each boom and platform function toggle switch.
- ⊙ Result: All boom and platform functions should operate through a full cycle.

Test the Tilt Sensor

- 9 Turn the key switch to platform control. Pull out the platform red Emergency Stop button to the on position.
- 10 Open the control panel side turntable cover and locate the tilt sensor next to the function manifold. 
- 11 Press down one side of the tilt sensor.
- ⊙ Result: The alarm, located in the platform, should sound.

Test Auxiliary Power

- 12 Turn the key switch to ground control.
- 13 Pull out the red Emergency Stop button to the on position.
- 14 Simultaneously hold the auxiliary power switch on and activate each boom function toggle switch. 

Note: To conserve battery power, test each function through a partial cycle.

- ⊙ Result: All boom functions should operate.

Inspections

At the Platform Controls

- 15 Turn the key switch to platform control.
 - 16 Pull out the red Emergency Stop button to the on position.
- ⦿ Result: The beacon (if equipped) should flash.

Test Emergency Stop

- 17 Push in the platform red Emergency Stop button to the off position.
- ⦿ Result: No functions should operate.

Test the Horn

- 18 Pull out the red Emergency Stop button to the on position.
 - 19 Press the horn button.
- ⦿ Result: The horn should sound.

Test the Foot Switch

- 20 Do not press down the foot switch and test each machine function.
- ⦿ Result: No functions should operate.

Test Machine Functions

- 21 Press down the foot switch.
 - 22 Activate each machine function control handle or toggle switch.
- ⦿ Result: All boom and platform functions should operate through a full cycle.

Note: Control the speed of boom functions by adjusting the boom function speed controller. Drive and steer functions are not affected by the boom function speed controller.

Test the Lift/Drive Select Function

- 23 Press down the foot switch.
 - 24 Move the drive control handle off center and activate a boom function control handle.
- ⦿ Result: No boom functions should operate. The machine will move in the direction indicated on the control panel.

Inspections

Test the Steering

- 25 Press down the foot switch.
- 26 Press the thumb rocker switch on top of the drive control handle in the direction indicated by the blue triangle on the control panel OR slowly move the control handle in the direction indicated by the blue triangle.
 - ⦿ Result: The steer wheels should turn in the direction that the blue triangles point on the drive chassis.
- 27 Press the thumb rocker switch in the direction indicated by the yellow triangle on the control panel OR slowly move the control handle in the direction indicated by the yellow triangle.
 - ⦿ Result: The steer wheels should turn in the direction that the yellow triangles point on the drive chassis.

Test Drive and Braking

- 28 Press down the foot switch.
- 29 Slowly move the drive control handle in the direction indicated by the blue arrow on the control panel until the machine begins to move, then return the handle to the center position.
 - ⦿ Result: The machine should move in the direction that the blue arrow points on the drive chassis, then come to an abrupt stop.
- 30 Slowly move the control handle in the direction indicated by the yellow arrow on the control panel until the machine begins to move, then return the handle to the center position.
 - ⦿ Result: The machine should move in the direction that the yellow arrow points on the drive chassis, then come to an abrupt stop.

Note: The brakes must be able to hold the machine on any slope it is able to climb.

Inspections

Test the Drive Enable System

- 31 Press down the foot switch and lower the boom to the stowed position.
- 32 Rotate the turntable until the primary boom moves past one of the non-steer wheels.

- ⊙ Result: The drive enable indicator light should come on and remain on while the boom is anywhere in the range shown.



- 33 Move the drive control handle off center.
- ⊙ Result: The drive function should not operate.
- 34 Hold the drive enable toggle switch up or down and slowly move the drive control handle off center.
- ⊙ Result: The drive function should operate.

Note: When the drive enable system is in use, the machine may drive in the opposite direction that the drive and steer control handle is moved.

Use the color-coded direction arrows on the platform controls and the drive chassis to identify the direction of travel.

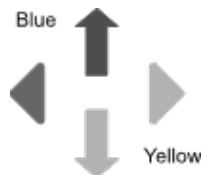

Test Limited Drive Speed

- 35 Press down the foot switch.
- 36 Raise the primary boom approximately 1 ft / 30 cm.
- 37 Slowly move the drive control handle to the full drive position.
- ⊙ Result: The maximum achievable drive speed with the primary boom raised should not exceed 1 ft / 30 cm per second.
- 38 Lower the primary boom to the stowed position.
- 39 Raise the secondary boom approximately 1 ft / 30 cm.
- 40 Slowly move the drive control handle to the full drive position.
- ⊙ Result: The maximum achievable drive speed with the secondary boom raised should not exceed 1 ft / 30 cm per second.
- 41 Lower the secondary boom to the stowed position.
- 42 Extend the primary boom approximately 1 ft / 30 cm.
- 43 Slowly move the drive control handle to the full drive position.
- ⊙ Result: The maximum achievable drive speed with the primary boom raised should not exceed 1 ft / 30 cm per second.
- 44 Retract the boom to the stowed position.

If the drive speed with the primary or secondary boom raised or the primary boom extended exceeds 1 ft/30 cm per second, immediately tag and remove the machine from service.

Inspections

Test Drive Tilt Cutout

- 45 Press down the foot switch.
- 46 With the boom fully stowed, drive the machine onto a slope where the chassis roll angle is greater than 4.5°.
 - ⊙ Result: The machine should continue to drive.
- 47 Return to level ground and raise the primary boom to an out of stowed position (approximately 10° above horizontal).
- 48 Drive the machine onto a slope where the chassis pitch angle is greater than 2.5°.
 - ⊙ Result: The machine should stop once the machine reaches 2.5° of chassis tilt and the alarm should sound at the platform controls.
- 49 Lower the primary boom to the stowed position.
 - ⊙ Result: The machine should drive.
- 50 Return to level ground and extend the primary boom approximately 1.6 ft / 0.5 m.
- 51 Drive the machine onto a slope where the chassis pitch angle is greater than 2.5°.
 - ⊙ Result: The machine should stop once the machine reaches 2.5° of chassis tilt and the alarm should sound at the platform controls.
- 52 Retract the primary boom to the stowed position.
 - ⊙ Result: The machine should drive.
- 53 Return to level ground and stow the boom.
- 54 With the boom fully stowed, drive the machine onto a slope where the chassis pitch angle is greater than 2.5°.
 - ⊙ Result: The machine should continue to drive.
- 55 Return to level ground and raise the secondary boom to an out of stowed position (approximately 15° above horizontal).
- 56 Drive the machine onto a slope where the chassis pitch angle is greater than 2.5°.
 - ⊙ Result: The machine should stop once the machine reaches 2.5° of chassis tilt and the alarm should sound at the platform controls.
- 57 Lower the secondary boom to the stowed position or drive in the opposite direction.
 - ⊙ Result: The machine should drive.
- 58 With the boom fully stowed, drive the machine onto a slope where the chassis pitch angle is greater than 2.5°.
 - ⊙ Result: The machine should continue to drive.
- 59 Return to level ground and raise the primary boom to an out of stowed position (approximately 10° above horizontal).
- 60 Drive the machine onto a slope where the chassis roll angle is greater than 4.5°.
 - ⊙ Result: The machine should stop once the machine reaches 4.5° of chassis tilt and the alarm should sound at the platform controls.
- 61 Lower the primary boom to the stowed position or drive in the opposite direction.
 - ⊙ Result: The machine should drive.

Inspections

- 62 Return to level ground and extend the primary boom approximately 1.6 ft / 0.5 m.
- 63 Drive the machine onto a slope where the chassis roll angle is greater than 4.5°.
- ⦿ Result: The machine should stop once the machine reaches 4.5° of chassis tilt and the alarm should sound at the platform controls.
- 64 Retract the primary boom to the stowed position.
- ⦿ Result: The machine should drive.
- 65 Return to level ground and stow the boom.
- 66 With the boom fully stowed, drive the machine onto a slope where the chassis roll angle is greater than 4.5°.
- ⦿ Result: The machine should continue to drive.
- 67 Return to level ground and raise the secondary boom to an out of stowed position (approximately 15° above horizontal).
- 68 Drive the machine onto a slope where the chassis roll angle is greater than 4.5°.
- ⦿ Result: The machine should stop once the machine reaches 4.5° of chassis tilt and the alarm should sound at the platform controls.
- 69 Lower the primary boom to the stowed position.
- ⦿ Result: The machine should drive.

Test Aircraft Protection Package (if equipped)

Note: Two people may be required to perform this test.

- 70 Extend the primary boom approximately 1 ft/30 cm.
- 71 Move the yellow bumper at the bottom of the platform 4 inches/10 cm in any direction.
- 72 Activate each function control handle or toggle switch.
- ⦿ Result: No boom and steer functions should operate.
- 73 Move and hold the aircraft protection override switch.

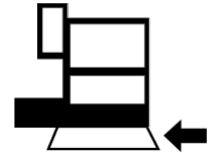

- 74 Activate each function control handle or toggle switch.
- ⦿ Result: All boom and steer functions should operate.

Inspections

Test the Contact Alarm (if equipped)

- 75 Do not activate the foot switch and press on the contact alarm cable to release the actuator from the switch socket.
- ⦿ Result: The contact alarm lights will not flash and the machine horn will not sound.
- 76 Activate the foot switch by pressing the foot switch down.
- ⦿ Result: The contact alarm lights will flash and the machine horn will sound.
- 77 Insert the actuator into the switch socket.
- ⦿ Result: The lights and horn will turn off.
- 78 Activate the foot switch by pressing the foot switch down and press on the contact alarm cable to release the actuator from the switch socket.
- ⦿ Result: The contact alarm lights will flash and the machine horn will sound.

- 79 Operate each machine function.
- ⦿ Result: All machine functions should not operate.
- 80 Insert the actuator into the switch socket.
- ⦿ Result: The lights and horn will turn off.
- 81 Operate each machine function.
- ⦿ Result: All machine functions should operate.

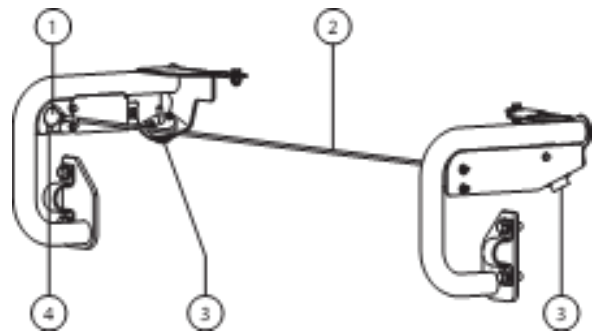

- 1 actuator
- 2 contact alarm cable
- 3 flashing alarm
- 4 switch socket

Inspections

Test Auxiliary Power

- 82 Pull out the red Emergency Stop button to the on position.
- 83 Press down the foot switch.
- 84 Simultaneously hold the auxiliary power switch on and activate each function control handle or toggle switch.

Note: To conserve battery power, test each function through a partial cycle.

- ⊙ Result: All boom and steer functions should operate. Drive functions should not operate with auxiliary power.

Inspections



Do Not Operate Unless:

- You learn and practice the principles of safe machine operation contained in this operator's manual.
 - 1 Avoid hazardous situations.
 - 2 Always perform a pre-operation inspection.
 - 3 Always perform function tests prior to use.
 - 4 Inspect the workplace.**

Know and understand the workplace inspection before going on to the next section.
 - 5 Only use the machine as it was intended.

Workplace Inspection Checklist

Be aware of and avoid the following hazardous situations:

- drop-offs or holes
- bumps, floor obstructions, or debris
- sloped surfaces
- unstable or slippery surfaces
- overhead obstructions and high voltage conductors
- hazardous locations
- inadequate surface support to withstand all load forces imposed by the machine
- wind and weather conditions
- the presence of unauthorized personnel
- other possible unsafe conditions

Workplace Inspection Fundamentals

The workplace inspection helps the operator determine if the workplace is suitable for safe machine operation. It should be performed by the operator prior to moving the machine to the workplace.

It is the operator's responsibility to read and remember the workplace hazards, then watch for and avoid them while moving, setting up, and operating the machine.

Inspections

Inspection for Decals with Words

Determine whether the decals on your machine have words or symbols. Use the appropriate inspection to verify that all decals are legible and in place.

Part No.	Decal Description	Qty
28164	Notice – Hazardous Materials	1
28174	Label – Power to Platform, 230V*	2
28235	Label – Power to Platform, 115V*	2
28236	Warning – Improper Operation	1
28372	Label – Disconnect Battery Pack Plug**	2
31060	Danger – Tip-over Hazard, Limit Switch	6
31508	Danger – Electrocution Hazard	1
31785	Notice – Battery Charger Operating Instr.	2
31788	Danger – Explosion/Burn Hazard	2
32728	Label – Generator (option)*	1
37053	Arrow – Blue	1
37054	Arrow – Yellow	1
37055	Triangle – Blue	2
37056	Triangle – Yellow	2
38149	Label – Patent	1
40299	Notice – Battery Connection Diagram	2
40300	Danger – Tip-over, Batteries	2
44980	Label – Power to Charger, 115V*	1
44981	Label – Air Line to Platform*	2
46468	Function Override (Aircraft Protection Package)*	1
48731	Label – FM Approval (option)*	1
48732	Label – EE Rating (option)*	1
52475	Label – Transport Tie Down**	4
52865	Warning – Annual Inspection Record	1
65171	Label – Circuit Breaker & Status Light	1
72081	Platform Control Panel	1
72086	Label – Lifting Point**	4
72833	Label – Open**	2
72867	Label – Work Lights (option)*	1
72875	Warning – Pipe Cradle (option)***	2
82366	Label – Chevron Rando*	1
82592	Ground Control Panel	1
97815	Label – Lower Mid-rail	1

Part No.	Decal Description	Qty
114343	Label – Emergency Lowering	1
114390	Danger – Electrocution Hazard	3
114397	Danger – Tilt-Alarm	1
133286	Label – Power to Charger*	1
139587	Label – Wheel Load, Z34 DC***	4
139590	Label – Wheel Load, Z-34N***	4
218550	Danger – Tip-over Hazard, 500 lbs / 227 kg*	1
218559	Danger, Warning – Tip-over, Crush Hazard	1
219487	Label – Platform Overload	1
227213	Instructions – Operating Instructions, Ground Controls	1
1263543	Warning – Compartment Access	3
1267121	Warning – Crush Hazard, Service	1
1272242	Label – Machine Registration/Owner Transfer	1
1278542	Label – Contact Alarm Weight***	1
1278982	Label – Actuator Switch Socket***	1
1280819	Label – Warning, Prop 65	1
1281174	Label – Lanyard Anchorage Point, Fall Arrest/Fall Restrained	6
1293324	Label – ICES-2/CAN-2 Compliance	1
1294398	Label – ANSI/CSA Compliant	1
1298510	Label – Transport and Lifting, Z-34	1
1298837	Label – Runaway Hazard, Slope Z-34N*	1
1298838	Label – Runaway Hazard, Slope, Z-34 DC*	1
1298845	Danger – Tip-over, Tire Specifications***	4
1298847	Danger – Tip-over, Tire Specifications, Z-30N, Z-34N***	4
1298858	Label – Relay Fuse Panel	1
1299791	Label – Maximum Capacity 440 lbs/200 kg, Manual Force 90 lbs/400 N*	1

* These decals are model, option or configuration specific.

** These decals are installed on both sides of chassis.

*** These decals are installed on both sides of chassis and are model, option, or configuration specific.

 Shading indicates decal is hidden from view, i.e. under covers

Inspections

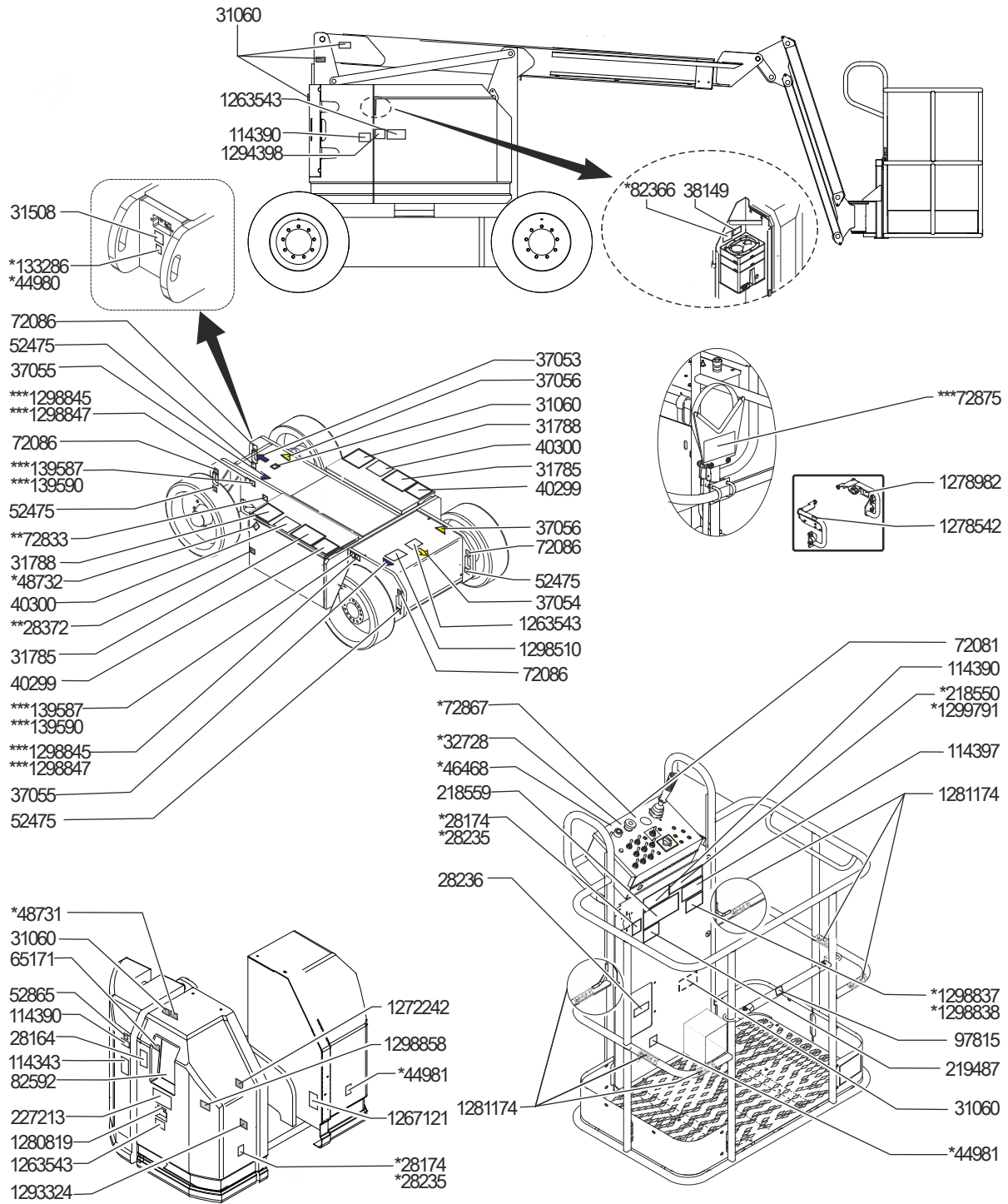

Inspections

Inspection for Decals with Symbols

Determine whether the decals on your machine have words or symbols. Use the appropriate inspection to verify that all decals are legible and in place.

Part No.	Decal Description	Qty
28174	Label – Power to Platform, 230V*	2
28235	Label – Power to Platform, 115V*	2
32728	Label – Generator (option)*	1
37053	Arrow – Blue	1
37054	Arrow – Yellow	1
37055	Triangle – Blue	2
37056	Triangle – Yellow	2
38149	Label – Patent	1
44980	Label – Power to Charger, 115V*	1
44981	Label – Air Line to Platform*	2
46468	Function Override (Aircraft Protection Package)*	1
48732	Label – EE Rating (option)*	1
52475	Label – Transport Tie Down**	4
72081	Platform Control Panel	1
72086	Label – Lifting Point**	4
72867	Label – Work Lights (option)*	1
82366	Label – Chevron Rando*	1
82481	Label – Battery/Charger Safety	2
82487	Label – Read the Manual***	6
82592	Ground Control Panel	1
82610	Label – Circuit Breaker & Status Light	1
82611	Label – Drive Enable Patch	1
97815	Label – Lower Mid-rail	1
114248	Label – Tip-over Hazard, Tilt Alarm	1
114249	Label – Tip-over Hazard, Tires***	4

Part No.	Decal Description	Qty
114252	Label – Tip-over Hazard, Limit Switches	6
114334	Label – Electrocutation Hazard, Plug	1
114343	Label – Emergency Lowering	1
133067	Label – Electrocutation Hazard	3
133286	Label – Power to Charger, Universal*	1
139587	Label – Wheel Load, Z-34/22 DC***	4
139590	Label – Wheel Load, Z-34/22N***	4
219954	Label – Tip-over Hazard*	1
219956	Label – Platform Overload	1
219958	Label – Tip-over, Crush Hazard	1
1263542	Label – Compartment Access	3
1272242	Label – Machine Registration/Owner Transfer	1
1278542	Label – Contact Alarm Weight	1
1278982	Label – Actuator Switch Socket*	1
1281174	Label – Lanyard Anchorage Point, Fall Arrest/Fall Restrained*	6
1286362	Label – Crush Hazard, Service	1
1294398	Label – ANSI/CSA Compliant	1
1298510	Label – Transport Diagram, Z-34	1
1298858	Label – Relay Fuse Panel, Z30/34 DC	1
1299436	Label – Slope Rating, Symbol – Z-30N, Z-34N*	1
1299437	Label – Slope Rating, Z-34 DC*	1
1299573	Label – Battery Weight, Z-34N, Z-34 DC	2
1299792	Label – Tip-over Hazard Aircraft Protection*	1

* These decals are model, option or configuration specific.

** These decals are installed on both sides of chassis.

*** These decals are installed on both sides of chassis and are model, option, or configuration specific.

 Shading indicates decal is hidden from view, i.e. under covers

Inspections

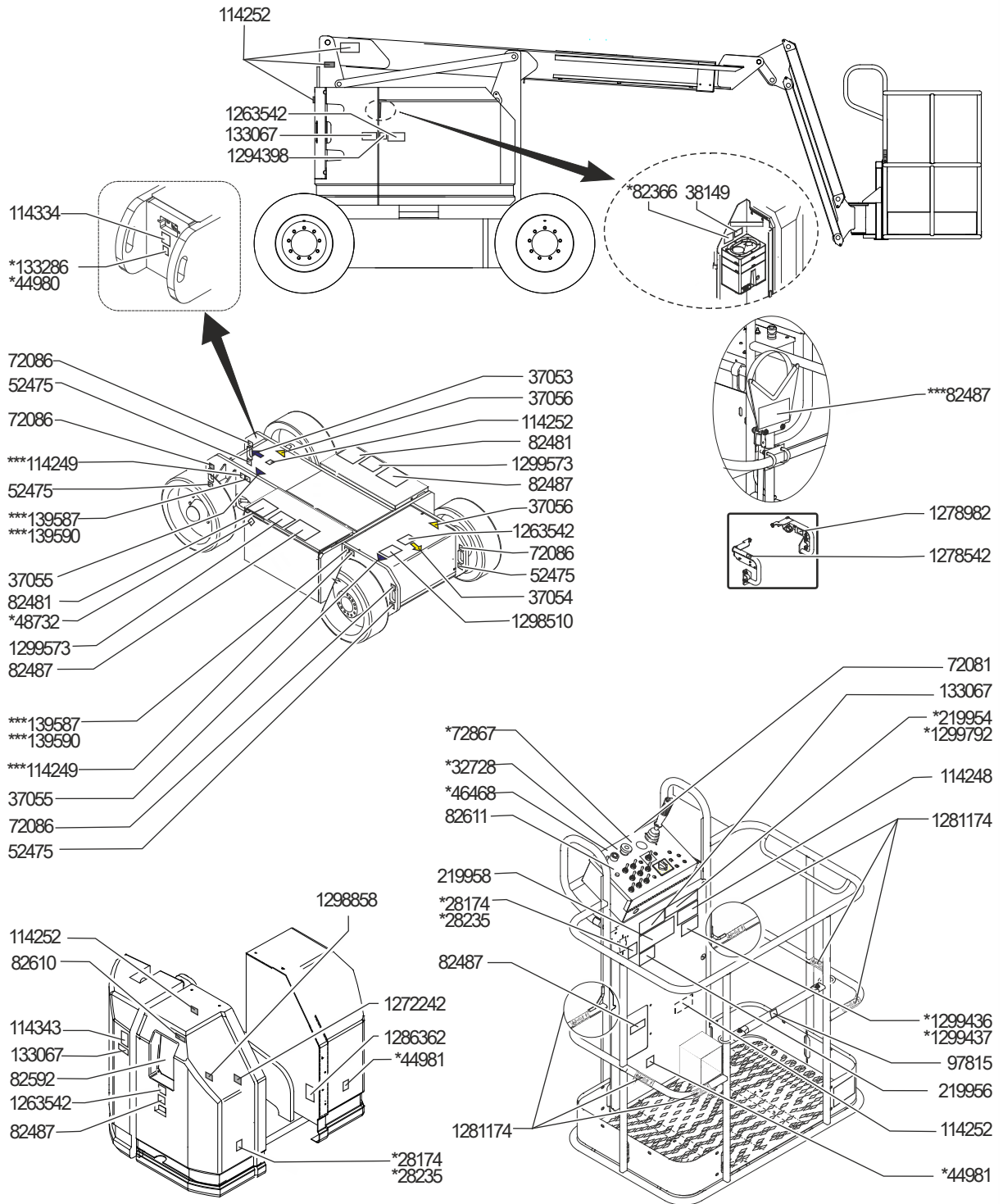

Operating Instructions



Do Not Operate Unless:

- You learn and practice the principles of safe machine operation contained in this operator's manual.
 - 1 Avoid hazardous situations.
 - 2 Always perform a pre-operation inspection.
 - 3 Always perform function tests prior to use.
 - 4 Inspect the workplace.
 - 5 **Only use the machine as it was intended.**

Fundamentals

The Operating Instructions section provides instructions for each aspect of machine operation. It is the operator's responsibility to follow all the safety rules and instructions in the operator's, safety, and responsibilities manuals.

Using the machine for anything other than lifting personnel, along with their tools and materials, to an aerial work site is unsafe and dangerous.

Only trained and authorized personnel should be permitted to operate a machine. If more than one operator is expected to use a machine at different times in the same work shift, they must all be qualified operators and are all expected to follow all safety rules and instructions in the operator's, safety, and responsibilities manuals. That means every new operator should perform a pre-operation inspection, function tests, and a workplace inspection before using the machine.

Operating Instructions

Emergency Stop

Push in the red Emergency Stop button to the off position at the ground controls or the platform controls to stop all functions.

Repair any function that operates when either red Emergency Stop button is pushed in.

Selecting and operating the ground controls will override the platform red Emergency Stop button.

Auxiliary Power

- 1 Use auxiliary power if the primary power source fails.
- 2 Simultaneously hold the auxiliary power switch on and activate the desired function.



Operation from Ground

- 1 Be sure both battery packs are connected before operating the machine.
- 2 Turn the key switch to ground control.
- 3 Pull out the red Emergency Stop button to the on position.

To Position Platform

- 1 Hold the function enable switch to either side.
- 2 Move the appropriate toggle switch according to the markings on the control panel.



Note: Drive and steer functions are not available from the ground controls.

Operating Instructions

Operation from Platform

- 1 Be sure both battery packs are connected before operating the machine.
- 2 Turn the key switch to platform control.
- 3 Pull out both ground and platform red Emergency Stop buttons to the on position.

To Position Platform

- 1 Set the boom function speed controller to the desired speed.

Note: Drive and steer functions are not affected by the boom function speed controller.

- 2 Press down the foot switch.
- 3 Move the appropriate toggle switch according to the markings on the control panel.

To Steer

- 1 Press down the foot switch.
- 2 Turn the steer wheels with the thumb rocker switch located on the top of the control handle.

Use the color-coded direction triangles on the platform controls and the drive chassis to identify the direction the wheels will turn.

To Drive

- 1 Press down the foot switch.
- 2 Increase speed: Slowly move the control handle off center.

Decrease speed: Slowly move the control handle toward center.

Stop: Return the control handle to center or release the foot switch.

Use the color-coded direction arrows on the platform controls and the drive chassis to identify the direction the machine will travel.

Machine travel speed is restricted when the booms are raised or extended.

Battery condition will affect machine performance.

Operating Instructions

▲ Driving on a slope

Determine the uphill, downhill and side slope ratings for the machine and determine the slope grade.



Maximum slope rating, platform downhill (gradeability):

Z-34/22N: 35% (19°)
Z-34/22 DC: 30% (17°)



Maximum slope rating, platform uphill:

20% (11°)



Maximum side slope rating:

25% (14°)

Note: Slope rating is subject to ground conditions with one person in the platform and adequate traction. Additional platform weight may reduce slope rating. The term gradeability applies to the platform downhill configuration only.

Be sure the boom is below horizontal and the platform is between the non-steer wheels.

To determine the slope grade:

Measure the slope with a digital inclinometer OR use the following procedure.

You will need:

- carpenter's level
- straight piece of wood, at least 3 feet/1 m long
- tape measure

Lay the piece of wood on the slope.

At the downhill end, lay the level on the top edge of the piece of wood and lift the end until the piece of wood is level.

While holding the piece of wood level, measure the vertical distance from the bottom of the piece of wood to the ground.

Divide the tape measure distance (rise) by the length of the piece of wood (run) and multiply by 100.

Example:

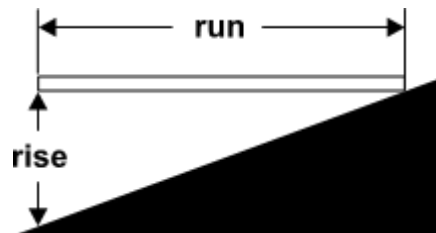

Piece of wood = 144 inches (3.6 m)

Run = 144 inches (3.6 m)

Rise = 12 inches (0.3 m)

$12 \text{ in} \div 144 \text{ in} = 0.083 \times 100 = 8.3\% \text{ grade}$

$0.3 \text{ m} \div 3.6 \text{ m} = 0.083 \times 100 = 8.3\% \text{ grade}$

If the slope exceeds the maximum uphill, downhill or side slope rating, then the machine must be winched or transported up or down the slope. See Transport and Lifting section.

Operating Instructions

Drive Enable

Light on indicates that the boom has moved just past either non-steer wheel and the drive function has been interrupted.



To drive, hold the drive enable switch up or down and slowly move the drive control handle off center.

Be aware that the machine may move in the opposite direction that the drive and steer controls are moved.

Always use the color-coded direction arrows on the platform controls and the drive chassis to identify the direction the machine will travel.

Low Voltage Interrupt (if equipped)

Machines equipped with Low Voltage Interrupt will lose primary and secondary boom up functions from the platform when batteries are low.

Machine Not Level Indicator Light



If the tilt alarm sounds when the platform is raised, use extreme caution. The machine not level indicator light will come on and the drive function in one or both directions will not operate. Identify the condition of the boom on the slope as shown below. Follow the steps to lower the boom before moving to a firm, level surface. Do not rotate the boom while lowering.

If the tilt alarm sounds with the platform uphill:

- 1 Lower the primary boom.
- 2 Lower the secondary boom.
- 3 Retract the primary boom.

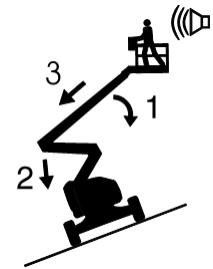

If the tilt alarm sounds with the platform downhill:

- 1 Retract the primary boom.
- 2 Lower the secondary boom.
- 3 Lower the primary boom.

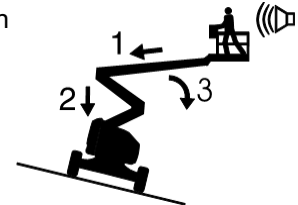

Operating Instructions

Tilt Sensor Activation Settings

Model	Chassis Angle (side to side)	Chassis Angle (front to back)
Z-34 N	4.5°	2.5°
Z-34 DC	4.5°	2.5°

When the Machine On Incline indicator light is on and the tilt alarm sounds, the following functions are affected; drive functions are disabled.



To restore drive functions, follow the boom lowering process, explained in the previous procedure.

When the machine is stowed, on a slope, and the tilt alarm sounds, the following functions are affected; lift functions are disabled.



Return the machine to level ground to restore lift functions.

Platform Overload Indicator Light



Light flashing indicates the platform is overloaded and no functions will operate.

Remove weight from the platform until the light goes off.

Aircraft Protection Package (if equipped)

If the platform bumpers come into contact with aircraft components, the machine will shut down and no functions will operate.

- 1 Start the engine.
- 2 Press down the foot switch.
- 3 Move and hold the aircraft protection function override switch.
- 4 Move the appropriate function control handle or toggle switch to move the machine away from aircraft components.

Operating Instructions

Contact Alarm (if equipped)

The contact alarm is designed to alert ground personnel when an operator makes contact with the platform control panel, interrupting boom movement, sounding an alarm and flashing warning lights.

When the contact alarm cable is tripped, the lift and drive functions are disabled at the platform. The audio and visual warnings will activate alerting others that assistance may be needed. These notifications will continue until the system is reset.

- 1 The contact alarm cable is tripped, releasing the actuator from the switch socket.
- 2 Insert the actuator into the switch socket to turn off flashing lights and audio alarm.

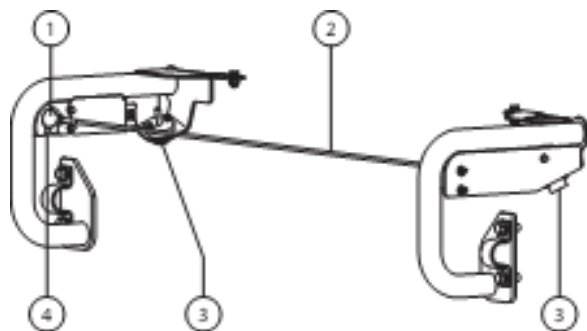

- 1 actuator
- 2 contact alarm cable
- 3 flashing alarm
- 4 switch socket

After Each Use

- 1 Select a safe parking location—firm level surface, clear of obstruction and traffic.
- 2 Retract and lower the boom to the stowed position.
- 3 Rotate the turntable so that the boom is between the non-steer wheels.
- 4 Turn the key switch to the off position and remove the key to secure from unauthorized use.

Machine Storage

Properly preparing and stowing the machine for extended storage will make it easier to put the machine back into service.

- 1 See After Each Use section for basic machine stowing instructions.
- 2 Store the machine in a dry and well-ventilated location. Be sure machine is clean and dry.
- 3 Perform a complete Pre-Operation Inspection.
Models with Engines: fill the fuel tank.
- 4 Refer to the Scheduled Maintenance section in the appropriate Service Manual, and complete each lubrication procedure.
- 5 Remove and store the battery.
- 6 Models with Engines: Refer to the OEM engine manual for additional extended storage procedures. As needed, start and run the engine for 10 minutes.

Operating Instructions



Battery and Charger Instructions

Observe and Obey:

- Do not use an external charger or booster battery.
- Charge the battery in a well-ventilated area.
- Use proper AC input voltage for charging as indicated on the charger.
- Use only a Genie authorized battery and charger.

To Charge Battery

- 1 Be sure the batteries are connected before charging the batteries.
- 2 Open the battery compartment. The compartment should remain open for the entire charging cycle.

Maintenance-free batteries

- 1 Connect the battery charger to a grounded AC circuit.
- 2 The charger will indicate when the battery is fully charged.

Standard Batteries

- 1 Remove the battery vent caps and check the battery acid level. If necessary, add only enough distilled water to cover the plates. Do not overfill prior to the charge cycle.
- 2 Replace the battery vent caps.
- 3 Connect the battery charger to a grounded AC circuit.
- 4 The charger will indicate when the battery is fully charged.
- 5 Check the battery acid level when the charging cycle is complete. Replenish with distilled water to the bottom of the fill tube. Do not overfill.

Dry Battery Filling and Charging Instructions

- 1 Remove the battery vent caps and permanently remove the plastic seal from the battery vent openings.
- 2 Fill each cell with battery acid (electrolyte) until the level is sufficient to cover the plates.

Do not fill to maximum level until the battery charge cycle is complete. Overfilling can cause the battery acid to overflow during charging. Neutralize battery acid spills with baking soda and water.

- 3 Install the battery vent caps.
- 4 Charge the battery.
- 5 Check the battery acid level when the charging cycle is complete. Replenish with distilled water to the bottom of the fill tube. Do not overfill.

Transport and Lifting Instructions



Observe and Obey:

- Genie provides this securement information as a recommendation. Drivers are solely responsible for making sure machines are properly secured and the correct trailer is selected pursuant to US Department of Transportation regulations, other localized regulations, and their company policy.
 - Genie customers needing to containerize any lift or Genie product should source a qualified freight forwarder with expertise in preparing, loading and securing construction and lifting equipment for international shipment.
 - Only qualified mobile elevating work platform operators should move the machine on, or off the truck.
 - The transport vehicle must be parked on a level surface.
 - The transport vehicle must be secured to prevent rolling while the machine is being loaded.
 - Be sure the vehicle capacity, loading surfaces and chains or straps are sufficient to withstand the machine weight. Genie lifts are very heavy relative to their size. See the serial label for the machine weight.
- Be sure the turntable is secured with the turntable rotation lock before transporting. Be sure to unlock the turntable for operation.
 - Do not drive the machine on a slope that exceeds the uphill, downhill or side slope rating. See Driving on a Slope in the Operating Instructions section.
 - If the slope of the transport vehicle bed exceeds the maximum slope rating, the machine must be loaded and unloaded using a winch as described in the brake release operation.

Transport and Lifting Instructions

Free-wheel Configuration for Winching

- 1 Chock the wheels to prevent the machine from rolling.
- 2 Release the non-steer wheel brakes by turning over the drive hub disconnect caps.

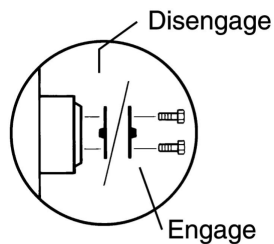

- 3 Be sure the winch line is properly secured to the drive chassis tie points and the path is clear of all obstructions.

After the machine is loaded:

- 1 Chock the wheels to prevent the machine from rolling.
- 2 Apply the non-steer wheel brakes by turning over the drive hub disconnect caps.

Towing the Genie Z-34 DC or the Genie Z-34N is not recommended. If the machine must be towed, do not exceed 2 mph/3.2 km/h.

Securing to Truck or Trailer for Transit

Always chock the machine wheels in preparation for transport.

Turn the key switch to the off position and remove the key before transporting.

Inspect the entire machine for loose or unsecured items.

Securing the Chassis

Use the tie-down points on the chassis for anchoring down to the transport surface.

Use chains or straps of ample load capacity.

Use a minimum of 4 chains or straps.

Adjust the rigging to prevent damage to the chains.

Securing the Platform

Make sure the jib and platform are in the stowed position.

Place a block under the edge of the platform beneath the platform entry.

Secure the platform with a nylon strap placed over the platform mount near the platform rotator (see below). Do not use excessive downward force when securing the boom section.

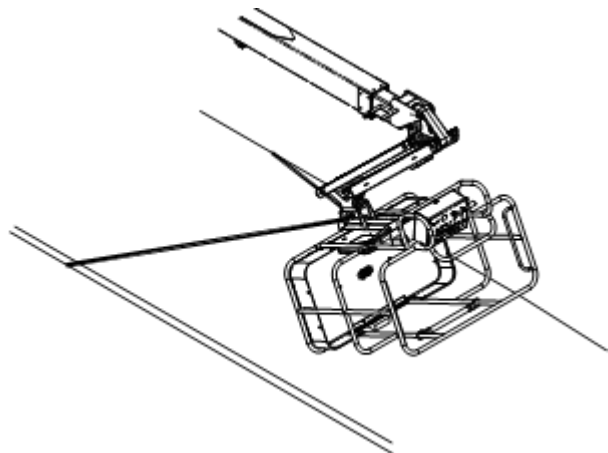

Transport and Lifting Instructions



Observe and Obey:

- ☑ Only qualified riggers should rig the machine.
- ☑ Only certified crane operators should lift the machine and only in accordance with the applicable crane regulations.
- ☑ Be sure the crane capacity, loading surfaces and straps or lines are sufficient to withstand the machine weight. See the serial label for the machine weight.

Lifting Instructions

Fully lower and retract the boom. Fully lower the jib. Remove all loose items on the machine.

Determine the center of gravity of your machine using the table and the picture on this page.

Attach the rigging only to the designated lifting points on the machine. There are four lifting points on the chassis.

Adjust the rigging to prevent damage to the machine and to keep the machine level.

Model	Z-34/22	Z-34/22N
Y Axis (1)	38.8 in 98.6 cm	32 in 81.2 cm
X Axis (2)	30.7 in 74.6 cm	34 in 86.3 cm

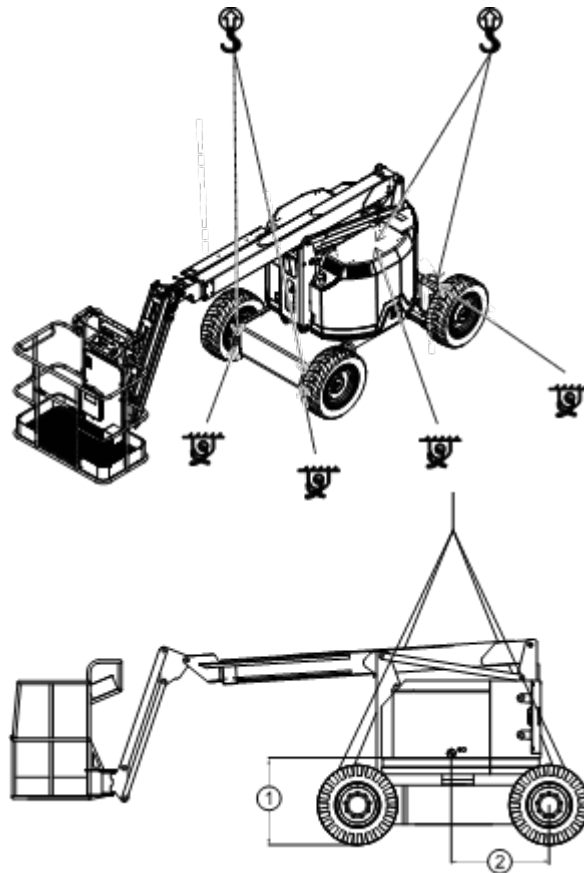

Maintenance



Observe and Obey:

- ☑ Only routine maintenance items specified in this manual shall be performed by the operator.
- ☑ Scheduled maintenance inspections shall be completed by qualified service technicians, according to the manufacturer's specifications and the requirements specified in the responsibilities manual.
- ☑ Dispose of material in accordance with governmental regulations.
- ☑ Use only Genie approved replacement parts.

Maintenance Symbols Legend

The following symbols have been used in this manual to help communicate the intent of the instructions. When one or more of the symbols appear at the beginning of a maintenance procedure, it conveys the meaning below.



Indicates that tools will be required to perform this procedure.



Indicates that new parts will be required to perform this procedure.

Check the Hydraulic Oil Level



Maintaining the hydraulic oil at the proper level is essential to machine operation. Improper hydraulic oil levels can damage hydraulic components. Daily checks allow the inspector to identify changes in oil level that might indicate the presence of hydraulic system problems.

- 1 Be sure that the boom is in the stowed position.
- 2 Check the hydraulic oil level.
- ⊙ Result: The hydraulic oil level should be within the FULL and ADD marks on the hydraulic tank.
- 3 Add oil as needed. Do not overfill.

Hydraulic oil specifications

Hydraulic oil type	Chevron Rando HD equivalent Premium MV equivalent
--------------------	--

Note: For cold weather operation and information on alternative hydraulic fluids, please refer to the Genie Boom Maintenance Manual.

Maintenance

Check the Batteries



Proper battery condition is essential to good machine performance and operational safety. Improper fluid levels or damaged cables and connections can result in component damage and hazardous conditions.

WARNING

Electrocution hazard. Contact with hot or live circuits may result in death or serious injury. Remove all rings, watches and other jewelry.

WARNING

Bodily injury hazard. Batteries contain acid. Avoid spilling or contacting battery acid. Neutralize battery acid spills with baking soda and water.

NOTICE

Perform this test after fully charging the battery.

- 1 Put on protective clothing and eye wear.
- 2 Be sure that the battery cable connections are tight and free of corrosion.

Standard Batteries

- 3 Remove the battery vent caps.
- 4 Check the battery acid level of each battery. If needed, replenish with distilled water to the bottom of the battery fill tube. Do not overfill.
- 5 Install the vent caps.

Scheduled Maintenance

Maintenance performed quarterly, annually and every two years must be completed by a person trained and qualified to perform maintenance on this machine according to the procedures found in the service manual for this machine.

Machines that have been out of service for more than three months must receive the quarterly inspection before they are put back into service.

Obey all local and governmental regulations regarding the disposal and decommissioning of the machine at the end of its lifetime. Refer to the appropriate Genie service manual for additional information.

Specifications

Z-34/22N

Height, working maximum	40 ft 6 in	12.5 m
Height, platform maximum	34 ft 6 in	10.5 m
Height, stowed maximum	6 ft 7 in	2 m
Horizontal reach, maximum	22 ft 3 in in	6.8 m
Width	4 ft 10 in	1.5 m
Length, stowed	18 ft 9 in	5.7 m
Maximum load capacity	500 lbs	227 kg
Maximum wind speed	28 mph	12.5 m/s
Wheelbase	6 ft 2 in	1.9 m
Turning radius (outside)	13 ft 5 in	4.1 m
Turning radius (inside)	7 ft	2.1 m
Ground clearance	5.5 in	14 cm
Turntable rotation		355°
Turntable tailswing	0 in	0 cm
Power source	8 Group 902, J305, 6V 315AH Batteries	

Drive speeds

Boom stowed	4.0 mph 40 ft/6.8 sec	6.4 km/h 12.2 m/6.8 sec
Boom raised or extended	0.6 mph 40 ft/40 sec	1.0 km/h 12.2 m/40 sec
Controls	24V DC Proportional	
Platform dimensions (length x width)	56 in x 30 in 1.42 m x 76 cm	

Platform leveling	self-leveling
Platform rotation	180°
AC outlet in platform	Standard
Hydraulic pressure, maximum (boom functions)	3200 psi 221 bar
System voltage	48V
Tire size, solid rubber	22 x 7 x 17.75 in

Weight

(Machine weights vary with option configurations. See serial label for specific machine weight.)

Maximum slope rating, stowed position

Platform downhill	35%	19°
Platform uphill	20%	11°
Side slope	25%	14°

Note: Slope rating is subject to ground conditions with one person in the platform and adequate traction. Additional platform weight may reduce slope rating.

Maximum allowable chassis inclination Refer to "Tilt Sensor Activation Settings" section

Ambient operating temperature -20° F to 120° F
-29° C to 49° C

Floor loading information

Tire load maximum	6450 lbs	2926 kg
Tire contact pressure (per tire)	103 psi	7.24 kg/cm ² 710 kPa
Occupied floor pressure	308 psf	14.75 kPa 1504 kg/m ²

Note: Floor loading information is approximate and does not incorporate different option configurations. It should be used only with adequate safety factors.

Continuous improvement of our products is a Genie policy. Product specifications are subject to change without notice or obligation.

Specifications

Z-34/22DC

Height, working maximum	40 ft 6 in	12.5 m
Height, platform maximum	34 ft 6 in	10.5 m
Height, stowed maximum	6 ft 7 in	2 m
Horizontal reach, maximum	22 ft 3 in	6.8 m
Width	5 ft 8 in	1.7 m
Length, stowed	18 ft 6 in	5.6 m
Maximum load capacity	500 lbs	227 kg
Maximum wind speed	28 mph	12.5 m/s
Wheelbase	6 ft 2 in	1.9 m
Turning radius (outside)	13 ft 1 in	4 m
Turning radius (inside)	5 ft 9 in	1.8 m
Ground clearance	6 in	15 cm
Turntable rotation		355°
Turntable tailswing	0 in	0 cm
Power source	8 Group 902, J305, 6V 315AH Batteries	

Drive speeds

Boom stowed	4.0 mph 40 ft/6.8 sec	6.4 km/h 12.2 m/6.8 sec
Boom raised or extended	0.6 mph 40 ft/40 sec	1.0 km/h 12.2 m/40 sec
Controls	24V DC Proportional	
Platform dimensions (length x width)	56 in x 30 in 1.42 m x 76 cm	

Platform leveling	self-leveling
Platform rotation	180°
AC outlet in platform	Standard
Hydraulic pressure, maximum (boom functions)	3200 psi 221 bar
System voltage	48V

Tire size	9-14.5 LT
Foam filled only	

Weight
(Machine weights vary with option configurations. See serial label for specific machine weight.)

Maximum slope rating, stowed position

Platform downhill	30%	17°
Platform uphill	20%	11°
Side slope	25%	14°

Note: Slope rating is subject to ground conditions with one person in the platform and adequate traction. Additional platform weight may reduce slope rating.

Maximum allowable chassis inclination	Refer to "Tilt Sensor Activation Settings" section
---------------------------------------	--

Ambient operating temperature	-20° F to 120° F -29° C to 49° C
-------------------------------	-------------------------------------

Floor loading information

Tire load maximum	5850 lbs	2654 kg
Tire contact pressure (per tire)	100 psi	7.03 kg/cm ² 689 kPa
Occupied floor pressure	239 psf	11.44 kPa 1167 kg/m ²

Note: Floor loading information is approximate and does not incorporate different option configurations. It should be used only with adequate safety factors.

Continuous improvement of our products is a Genie policy. Product specifications are subject to change without notice or obligation.

Specifications

Range of Motion Chart

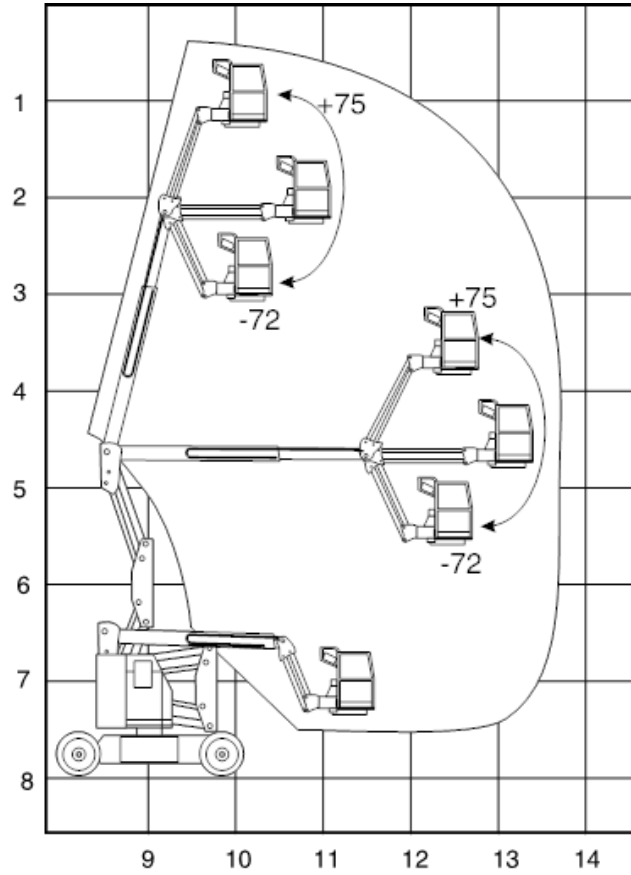

Max Height

1	35 ft	10.6 m
2	30 ft	9.1 m
3	25 ft	7.6 m
4	20 ft	6.1 m
5	15 ft	4.6 m
6	10 ft	3 m
7	5 ft	1.5 m
8	0 ft	0 m

Max Reach

9	0 ft	0 m
10	5 ft	1.5 m
11	10 ft	3 m
12	15 ft	4.6 m
13	20 ft	6.1 m
14	25 ft	7.6 m

California Proposition 65



Operating, servicing and maintaining this equipment can expose you to chemicals including engine exhaust, carbon monoxide, phthalates, and lead, which are known to the State of California to cause cancer and birth defects or other reproductive harm. These chemicals can be emitted from or contained in other various parts and systems, fluids and some component wear by-products. To minimize exposure, avoid breathing exhaust, do not idle the engine except as necessary, service your equipment and vehicle in a well-ventilated area and wear gloves or wash your hands frequently when servicing your equipment or vehicle and after operation. For more information go to www.P65Warnings.ca.gov/passenger-vehicle.